

S230 ...B/T

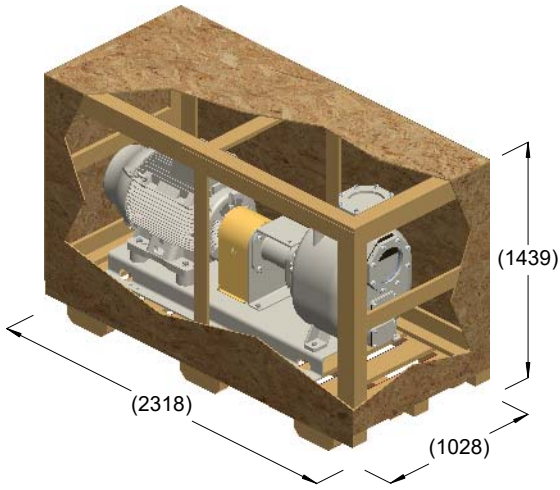

kg = 906
m³ = 3.43

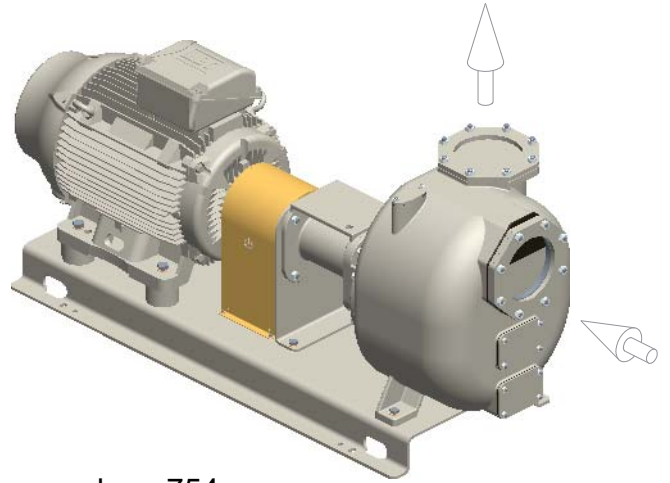

kg = 754

