

S220 ...B/T

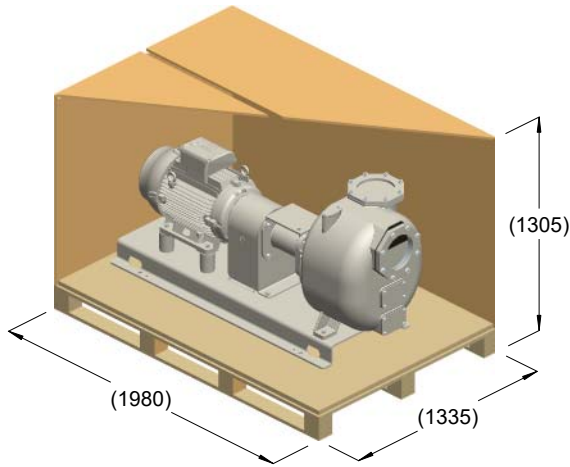

kg = 591
m³ = 2.50

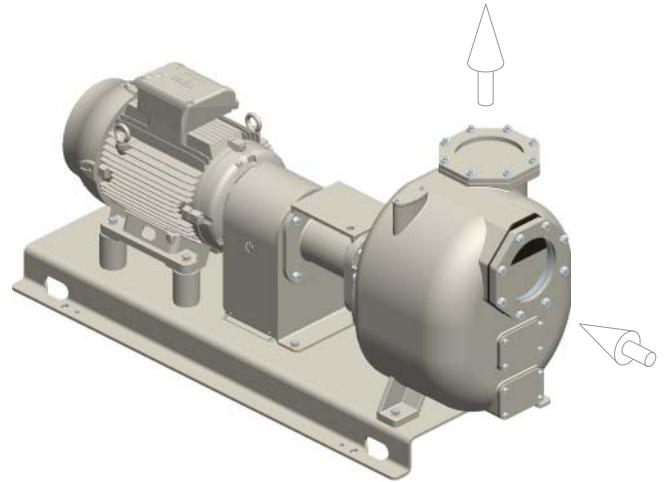

kg = 526

