

**S180 ...B+F/T**

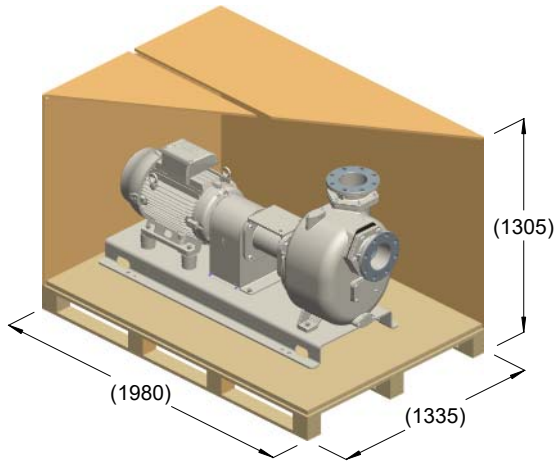

kg = 413  
m<sup>3</sup> = 2.50

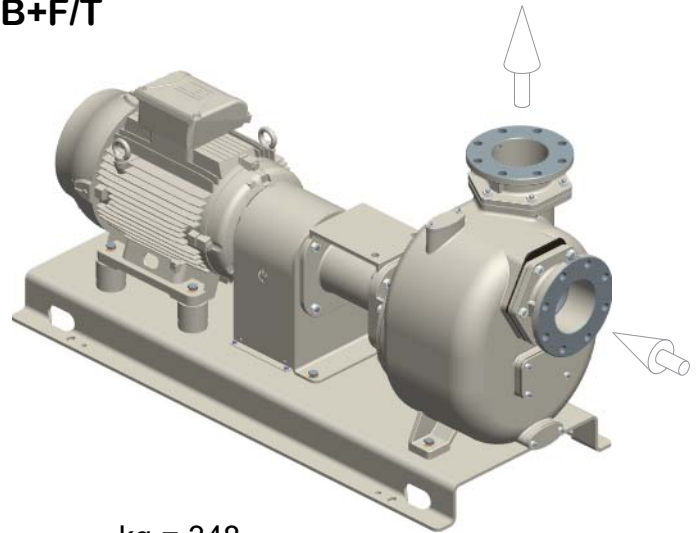

kg = 348

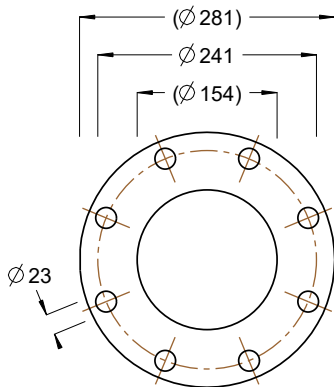
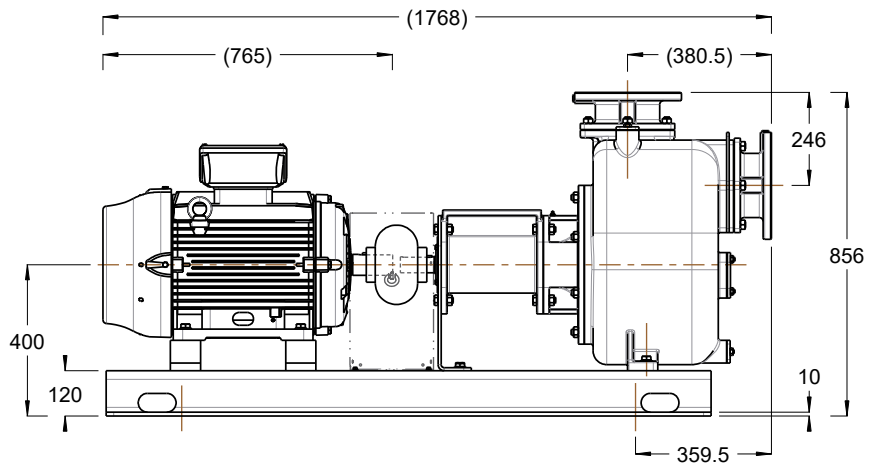
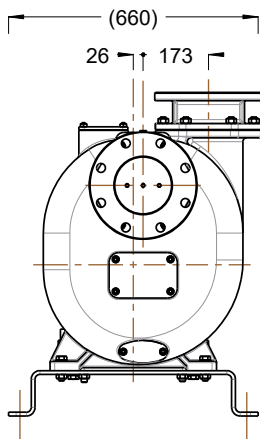

ISO DN150 PN16  
ANSI 6" 150lb

