

S180 ...B/T

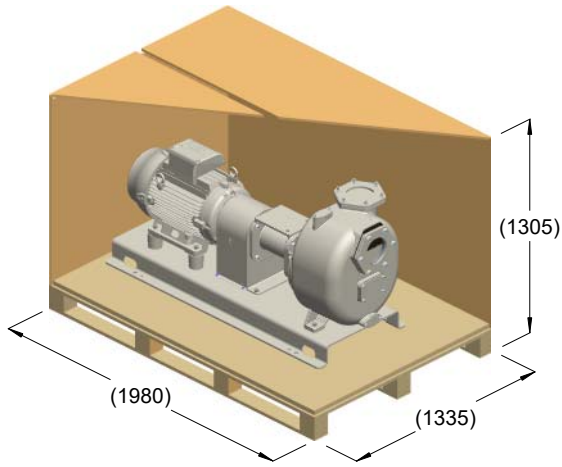

kg = 393
m³ = 2.50

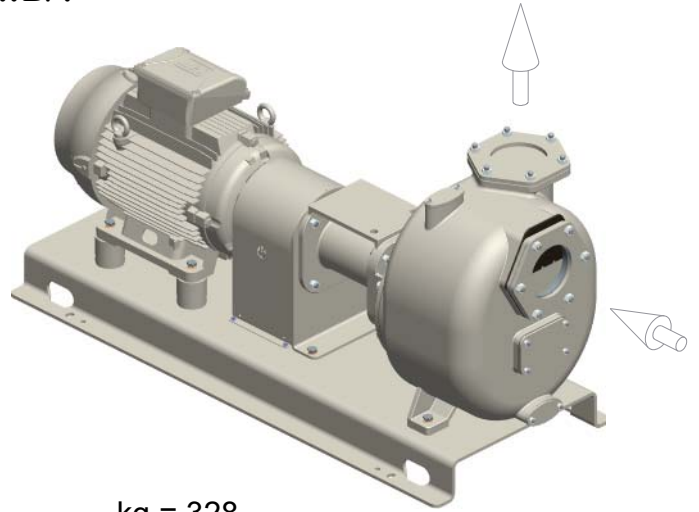

kg = 328

