

**S161 ...B+F/T**

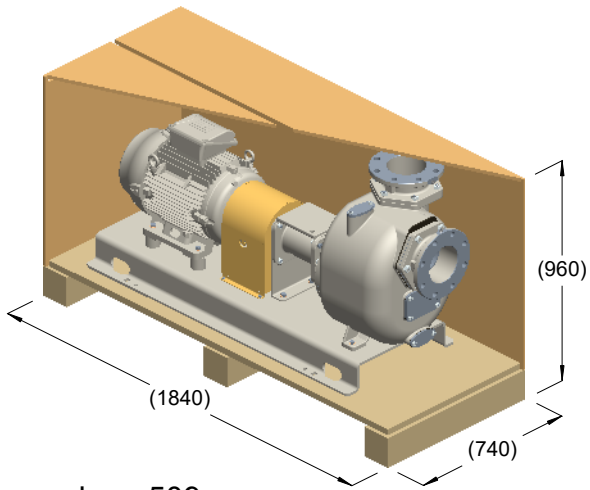

kg = 509  
m<sup>3</sup> = 1.29

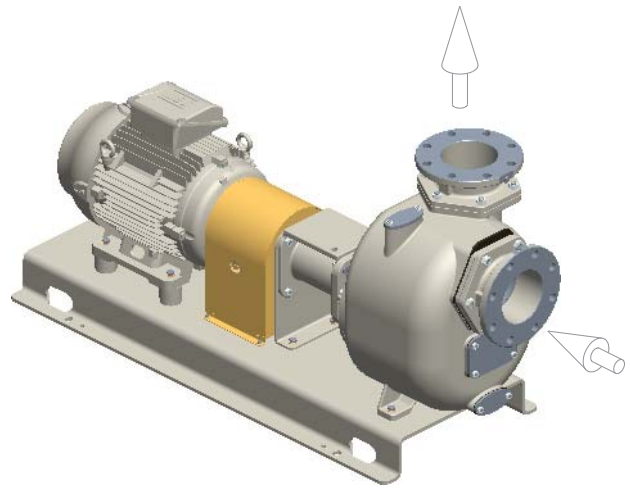

kg = 479

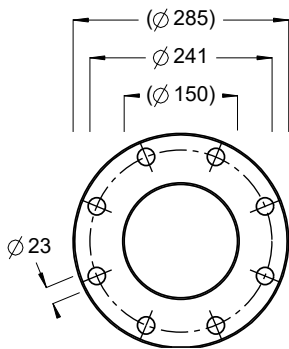
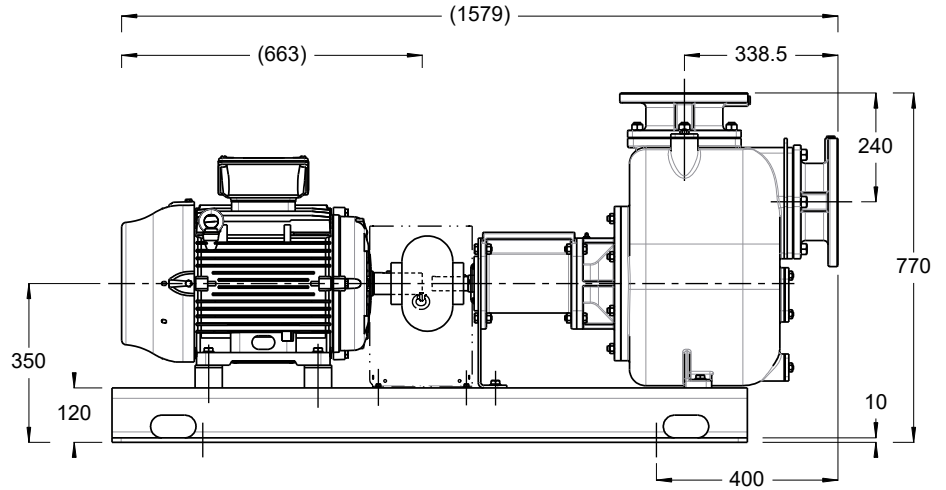
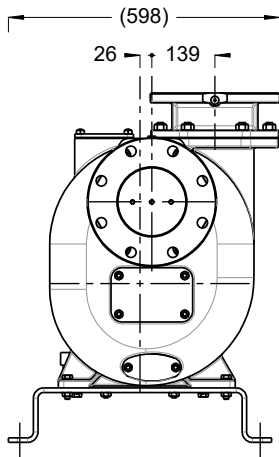

ISO DN150 PN16  
ANSI 6" 150lb

