

S161 ...B/T

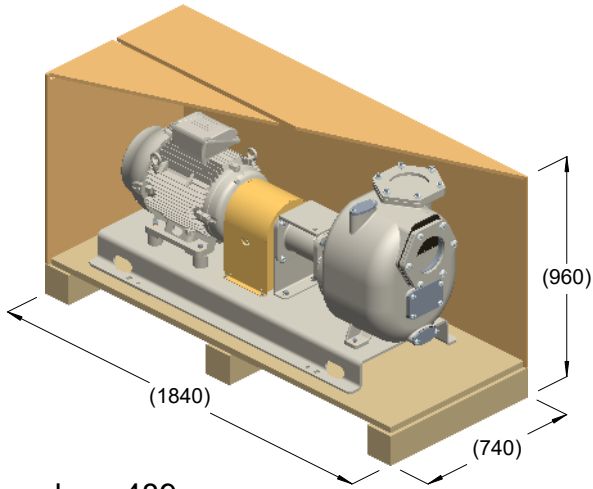

kg = 489
m³ = 1.29

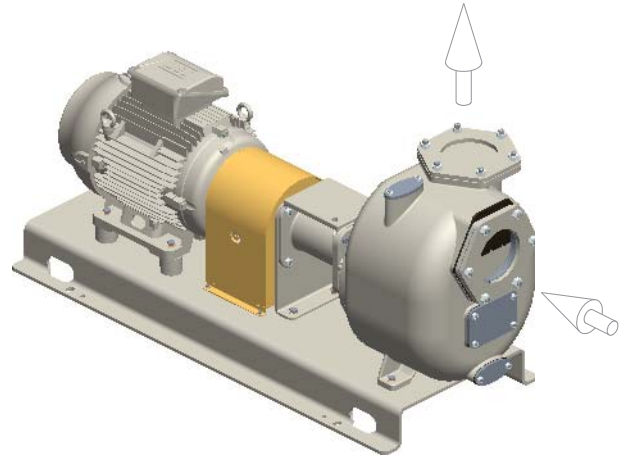

kg = 459

