

S150 ...B/T

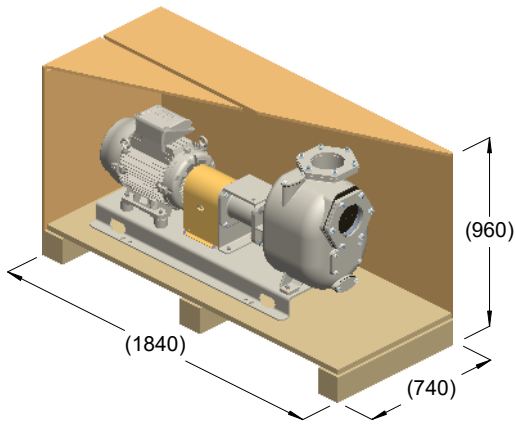

kg = 323
m³ = 1.29

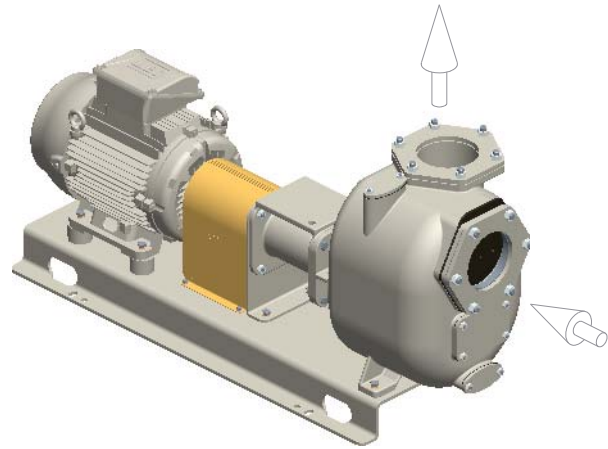

kg = 293

