

**S121 ...B+F/T**

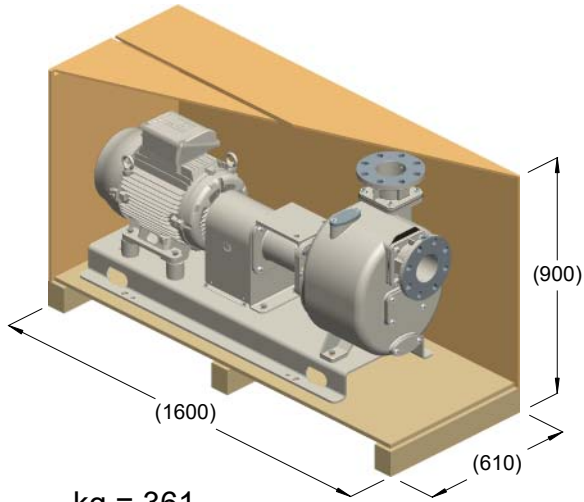

kg = 361  
m<sup>3</sup> = 0.88

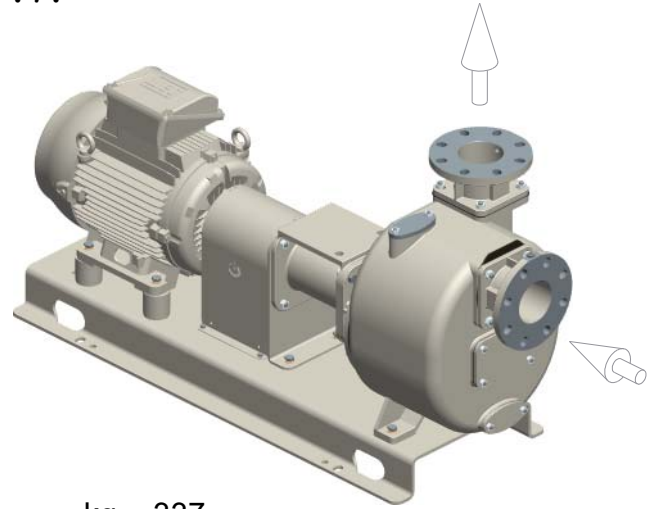

kg = 337

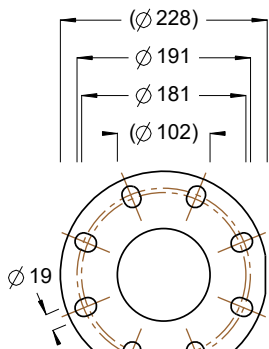
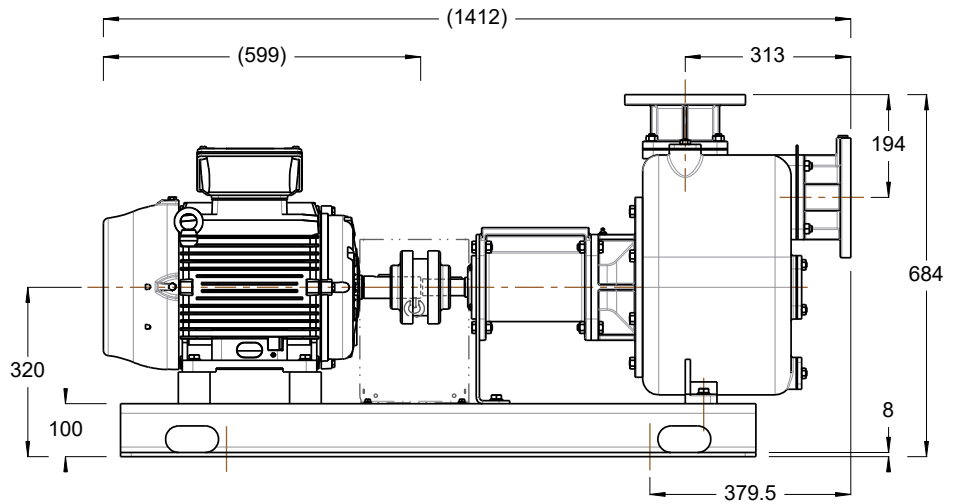
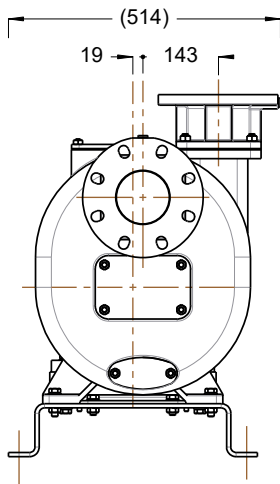

ISO DN100 PN16  
ANSI 4" 125lb

