

**S121 ...B/T**

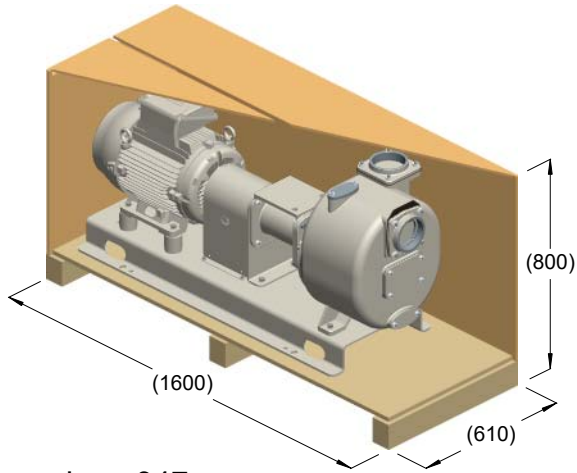

kg = 347  
m<sup>3</sup> = 0.78

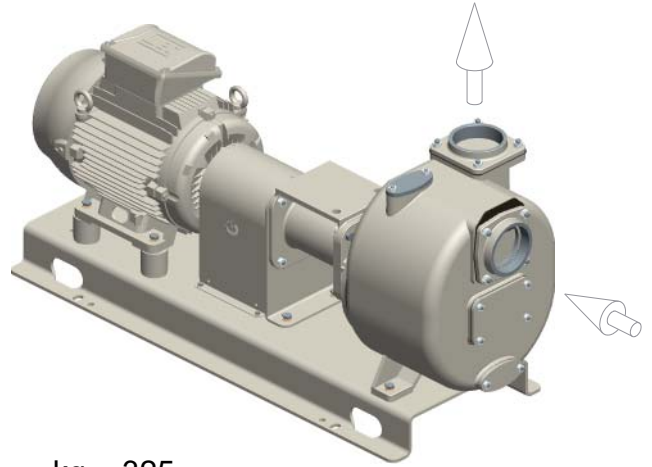

kg = 325

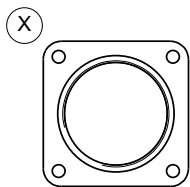
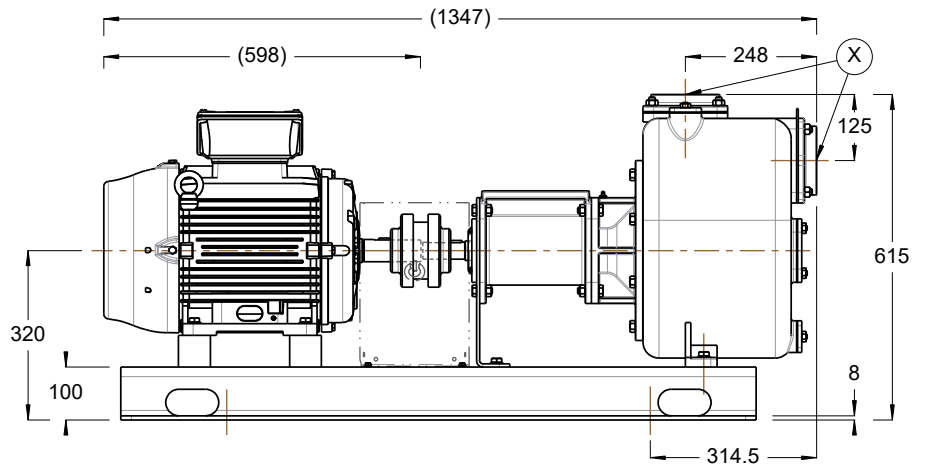
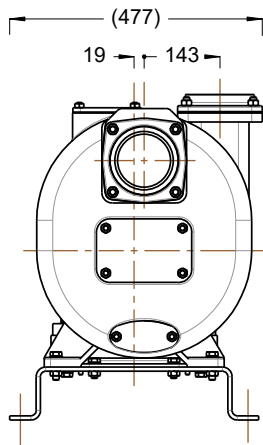

R4" BSP

