

S108 ...B+F/T

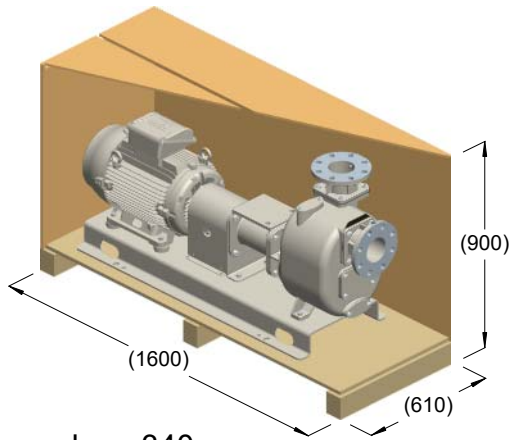

kg = 340
m³ = 0.88

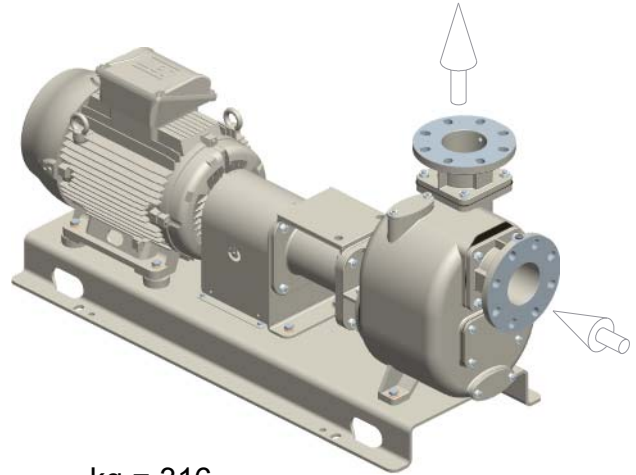

kg = 316

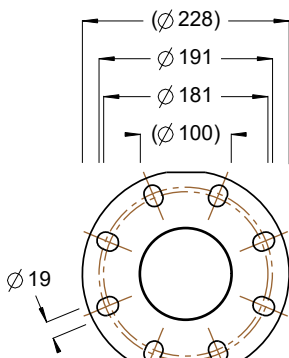
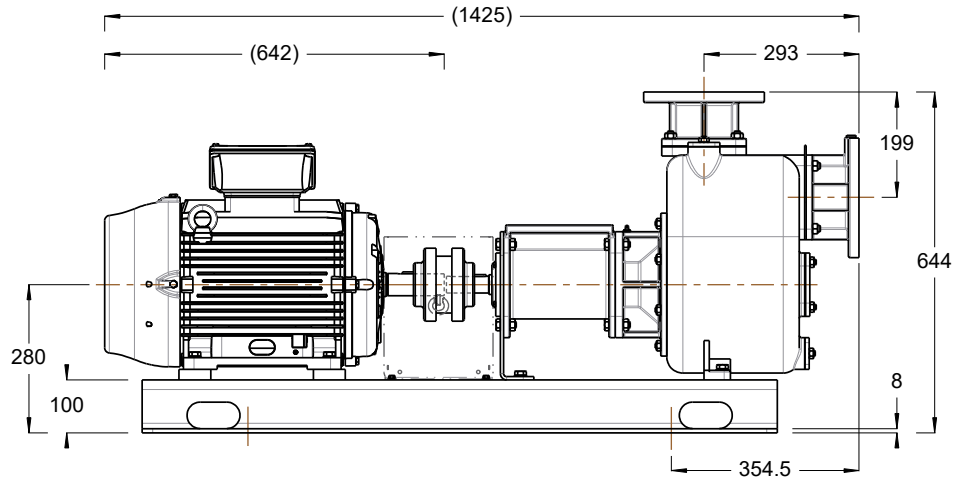
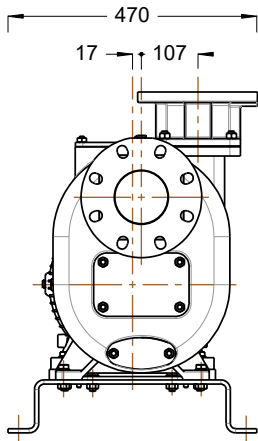

ISO DN100 PN16
ANSI 4" 125lb

