

S108 ...B/T

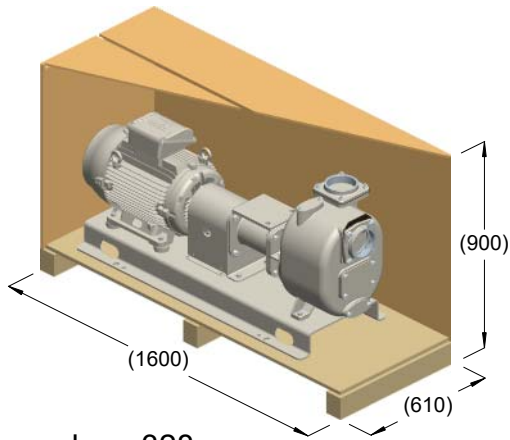

kg = 328
m³ = 0.88

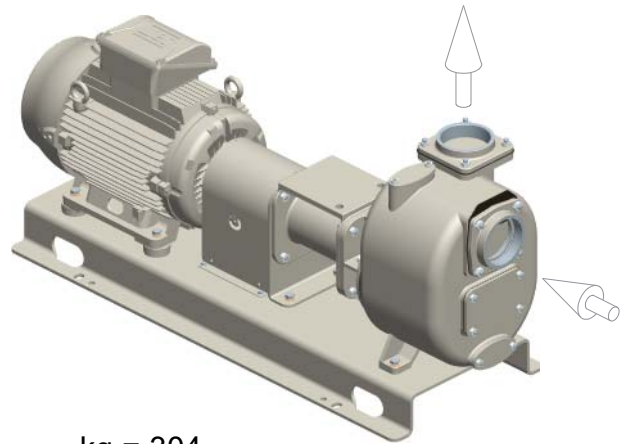

kg = 304

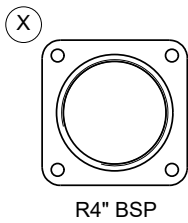
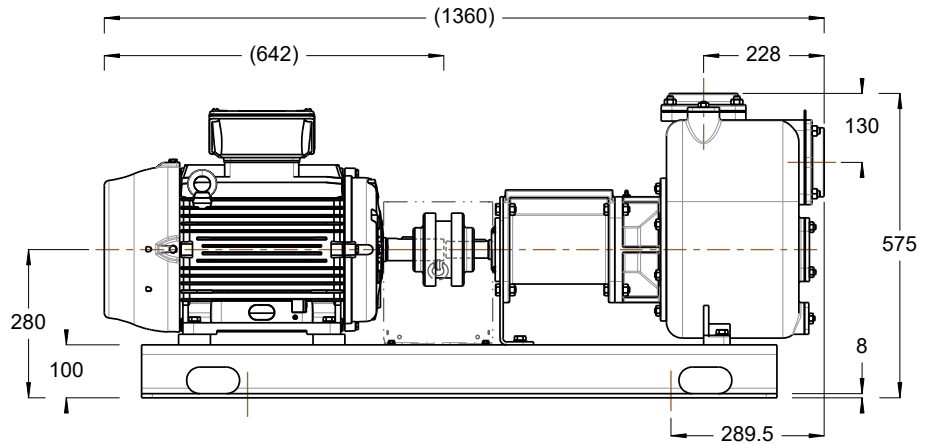
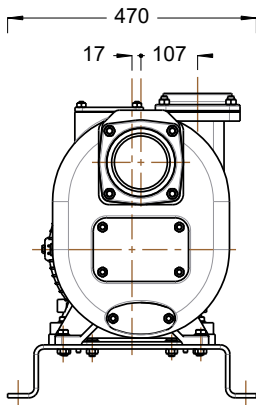

R4" BSP

