

**S105 ...B+F/T**

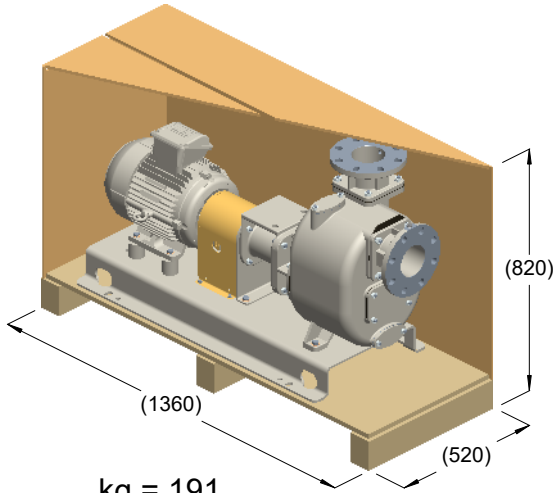

kg = 191  
m<sup>3</sup> = 0.58

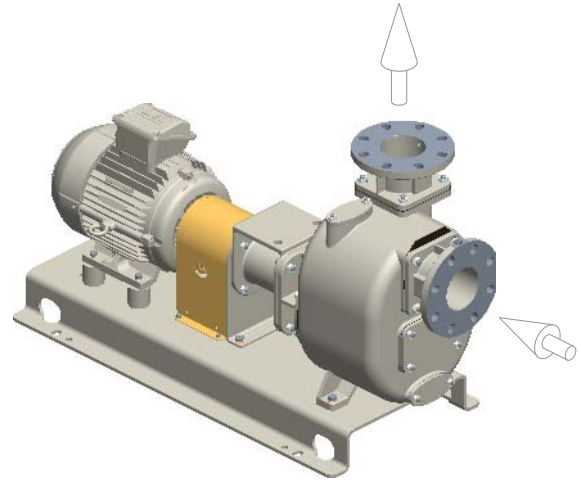

kg = 176

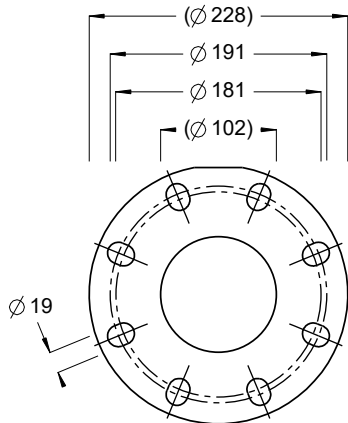
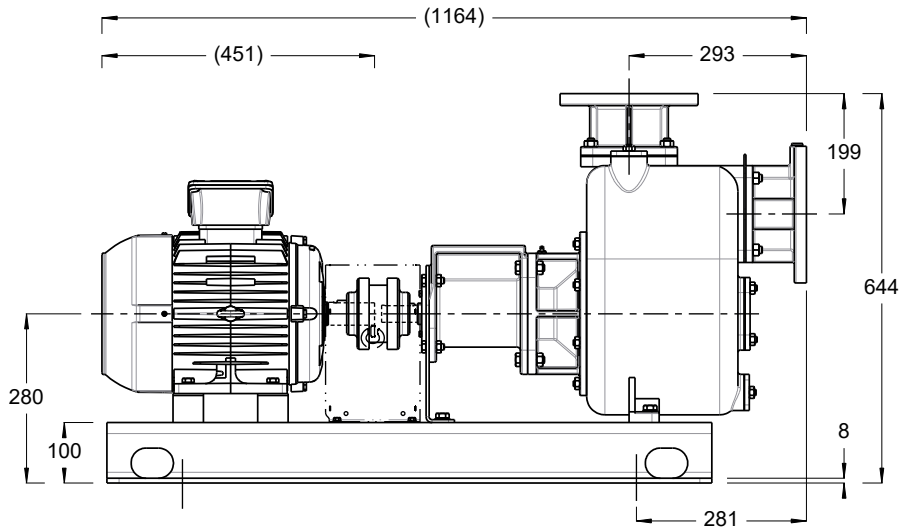
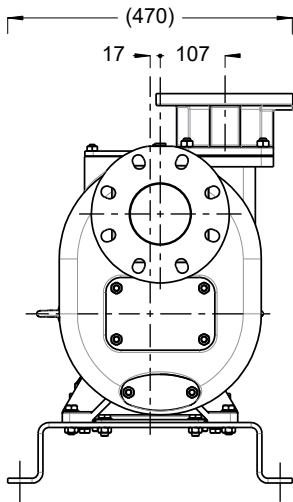

ISO DN100 PN16  
ANSI 4" 125lb

