

S 91 ...BBT+F

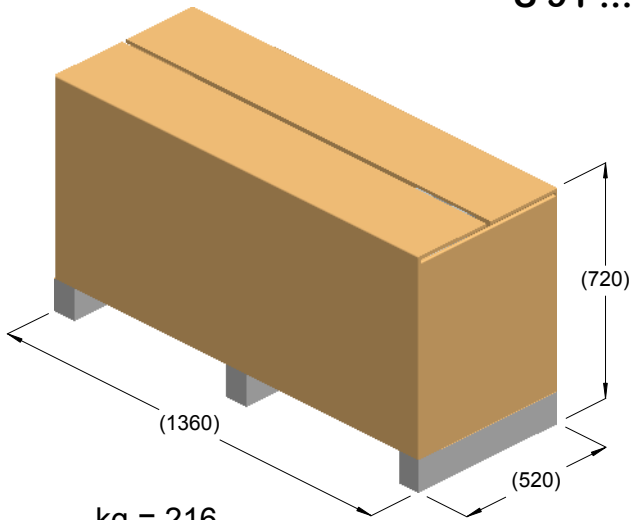

kg = 216
m³ = 0.51

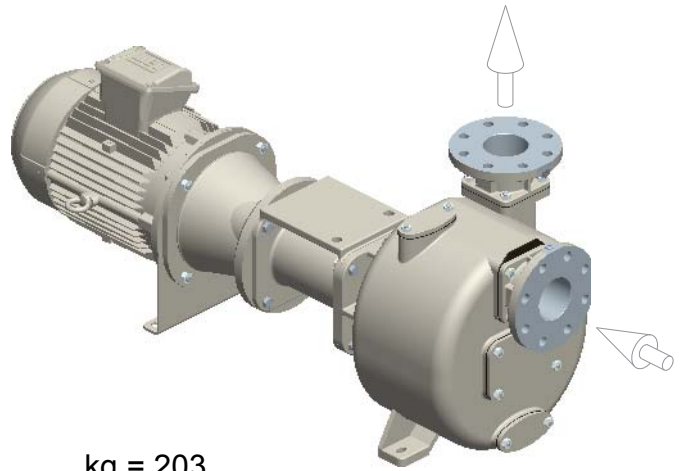

kg = 203

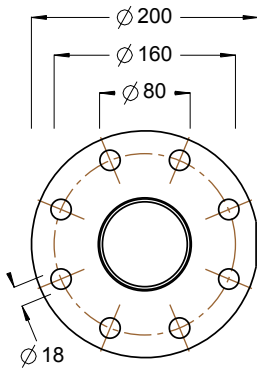
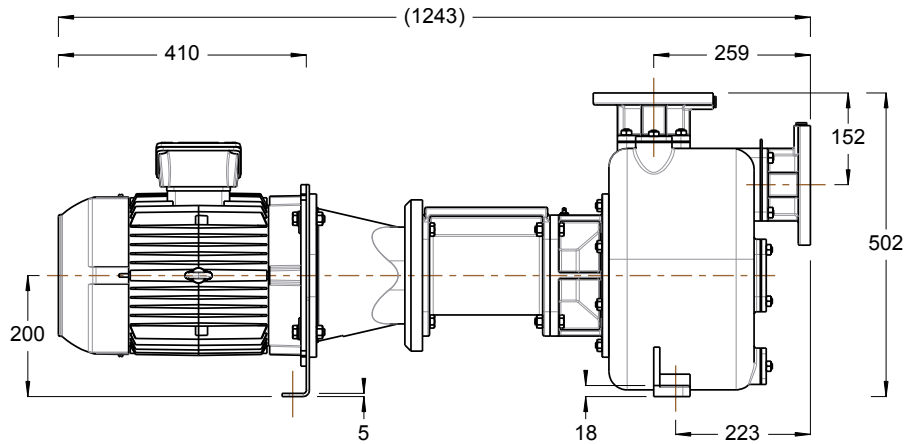
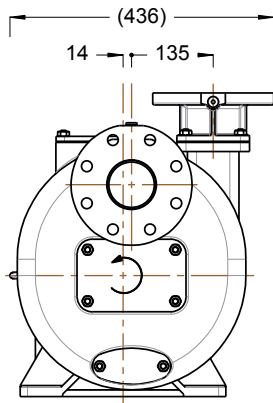

ISO DN80 PN16

