

S 88 K..BBT+F

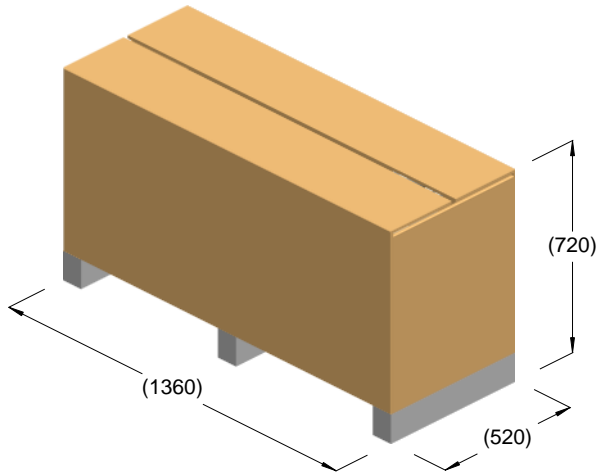

kg = 244
m³ = 0.51

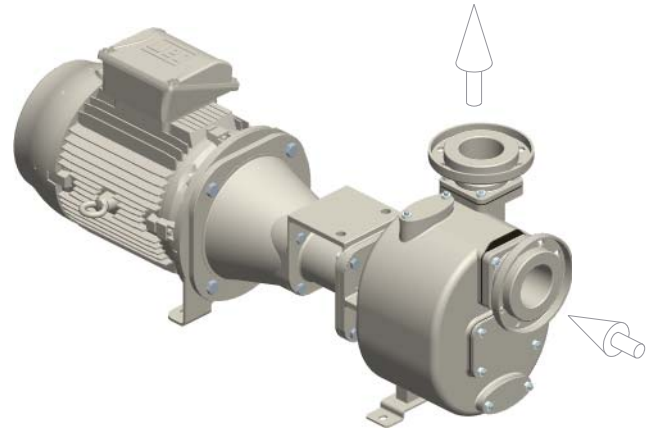

kg = 231

