

S 88 ...BBT

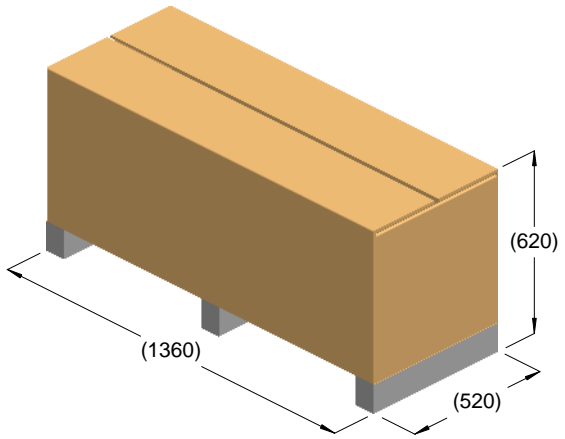

kg = 197
m³ = 0.44

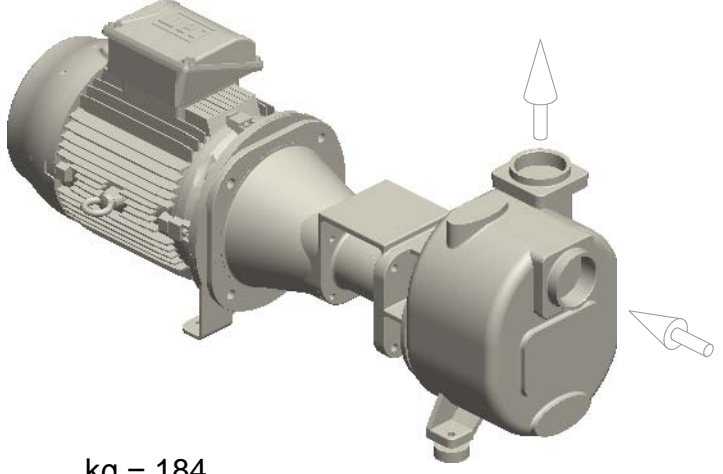

kg = 184

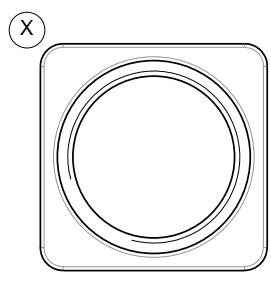
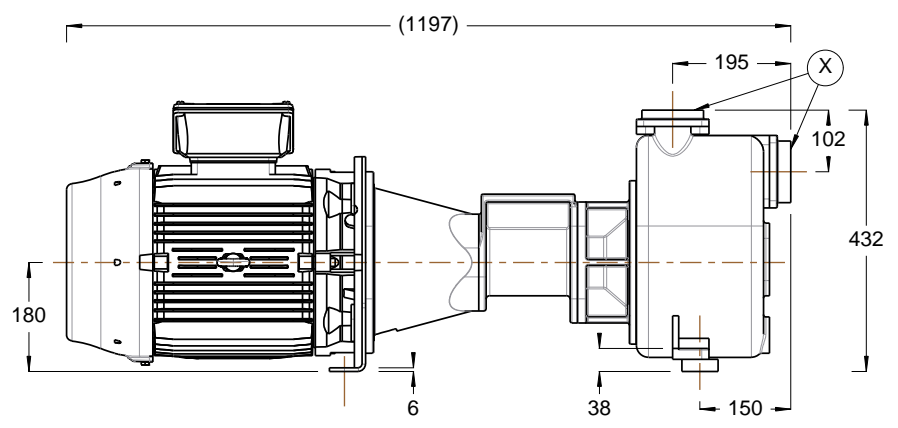
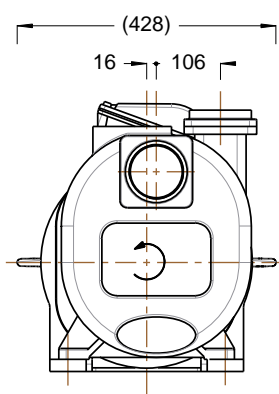

R3" BSP

