

S 85 ...BBT

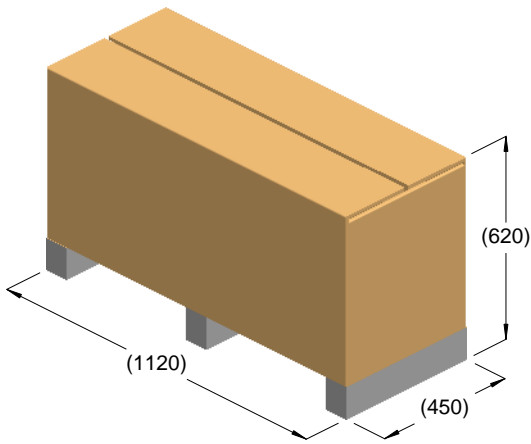

kg = 156
m³ = 0.31

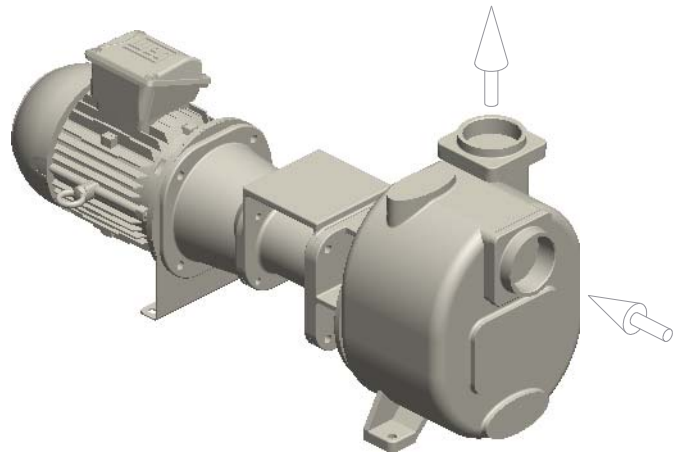

kg = 145

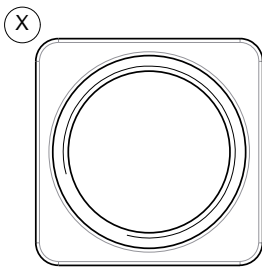
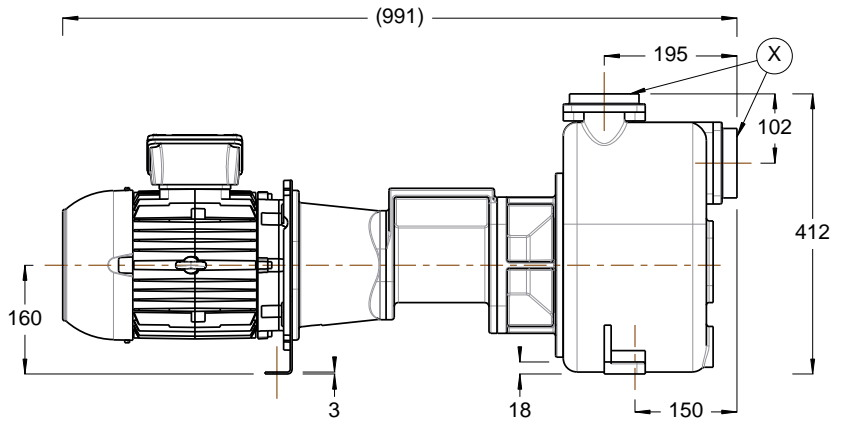
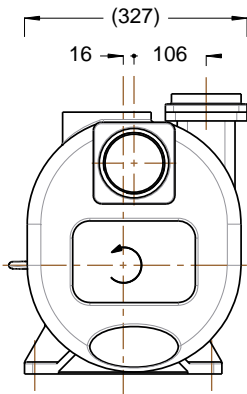

R3" BSP

