

S 83 ...BBT

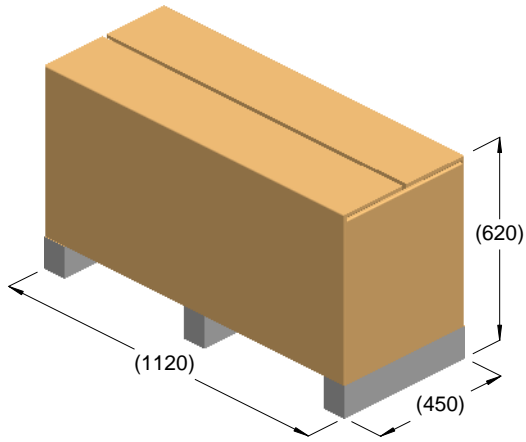

kg = 133
m³ = 0.31

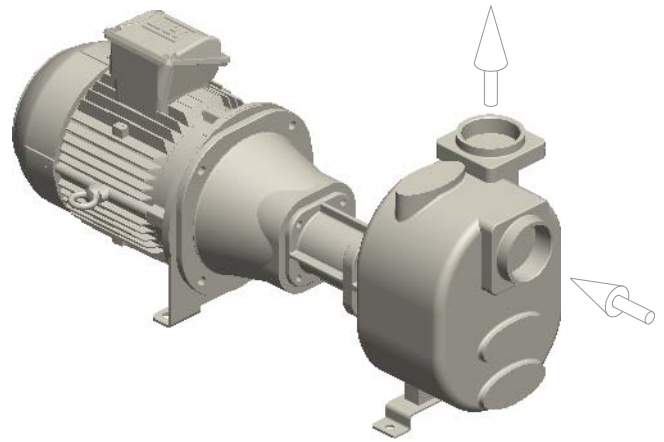

kg = 123

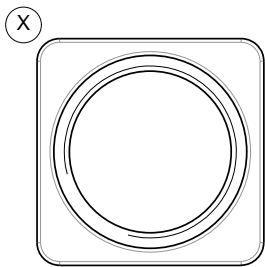
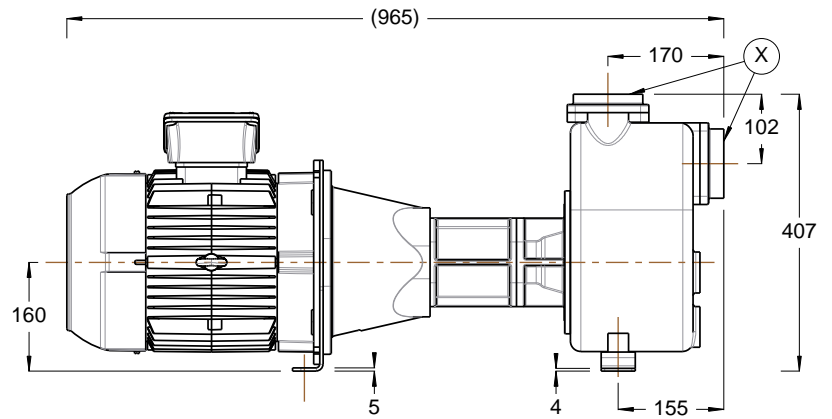
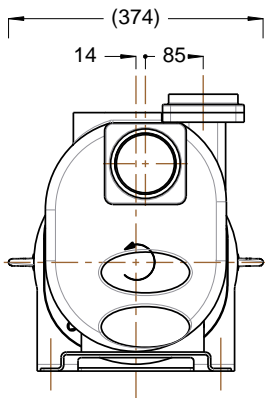

R3" BSP

