

S 82 K..BBT52

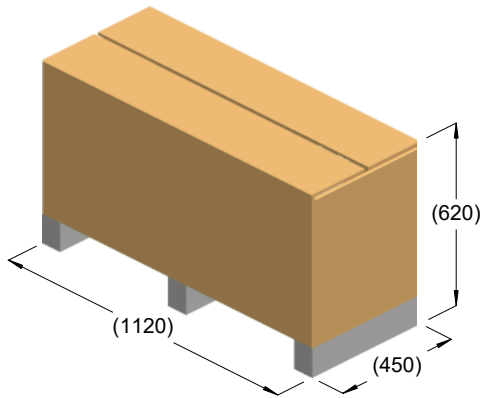

kg = 140
m³ = 0.31

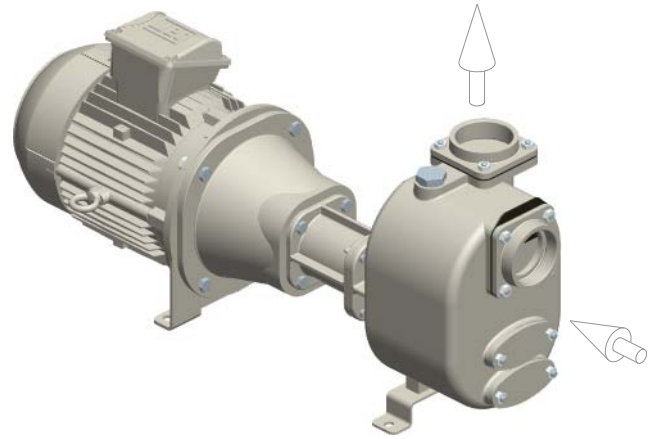

kg = 130

