

S 82 K..BBT52+F

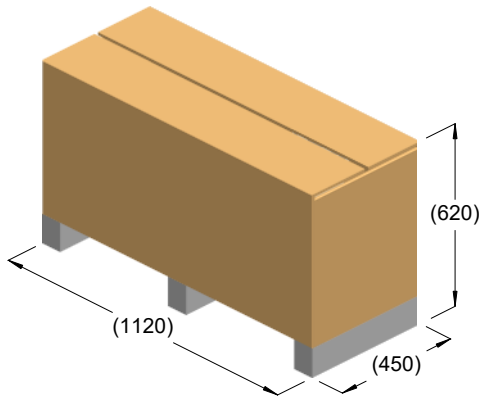

kg = 145
m³ = 0.31

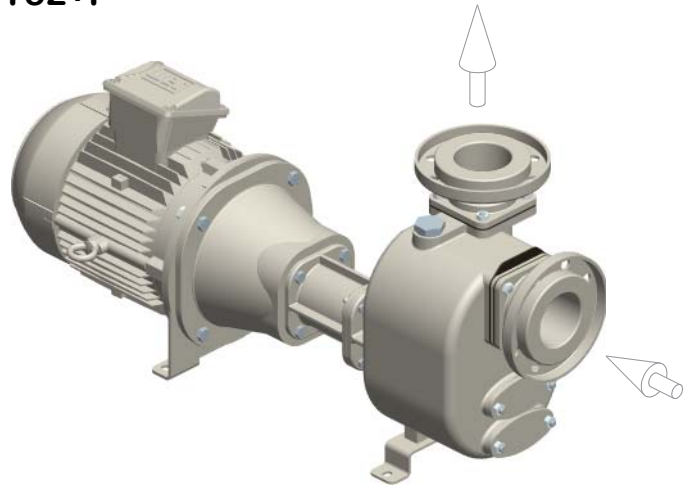

kg = 135

