

S 80 ...BBT52

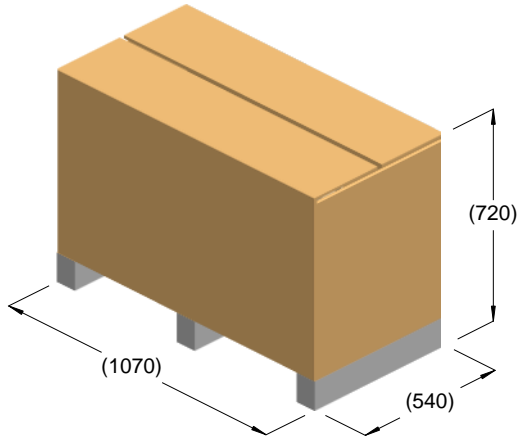

kg = 140
m³ = 0.42

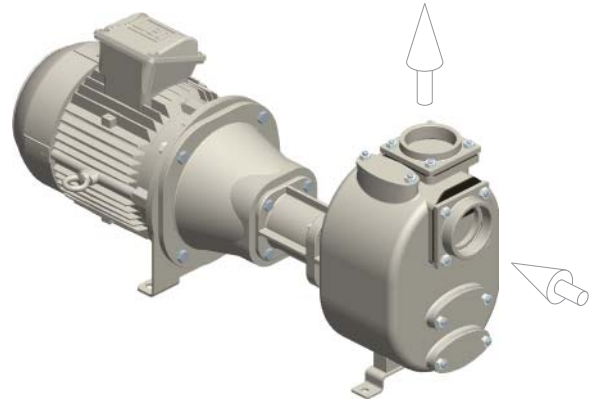

kg = 126

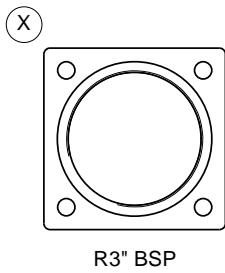
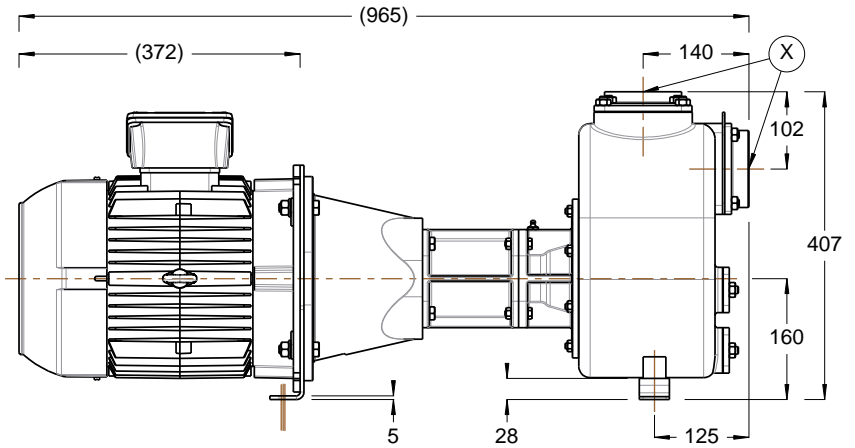
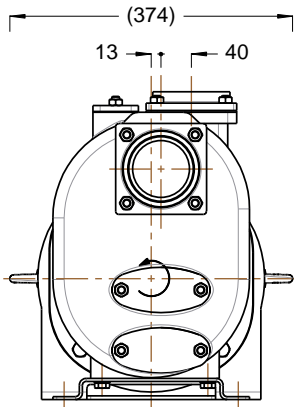

R3" BSP

