

S 80 ...BBT

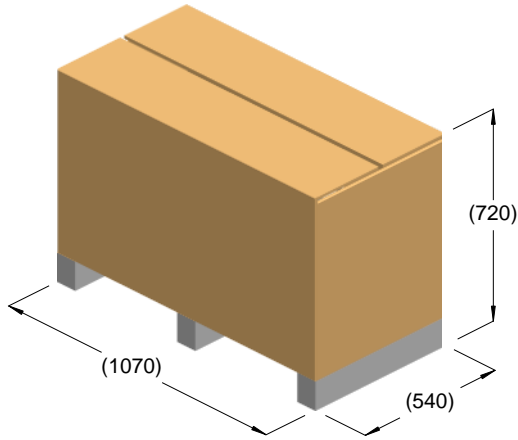

kg = 115
m³ = 0.42

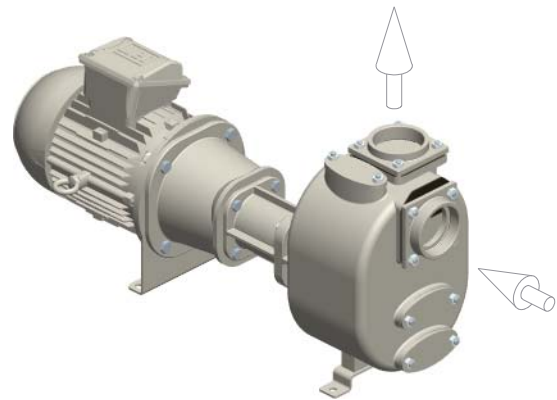

kg = 101

