

S 69 K..BBT

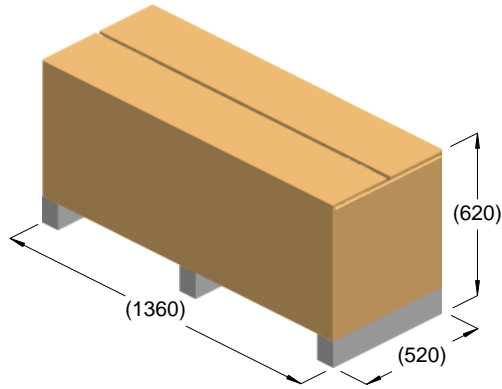

kg = 203
m³ = 0.44

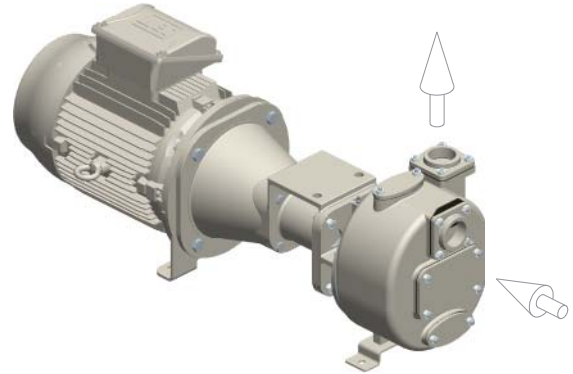

kg = 190

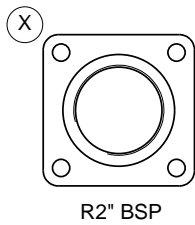
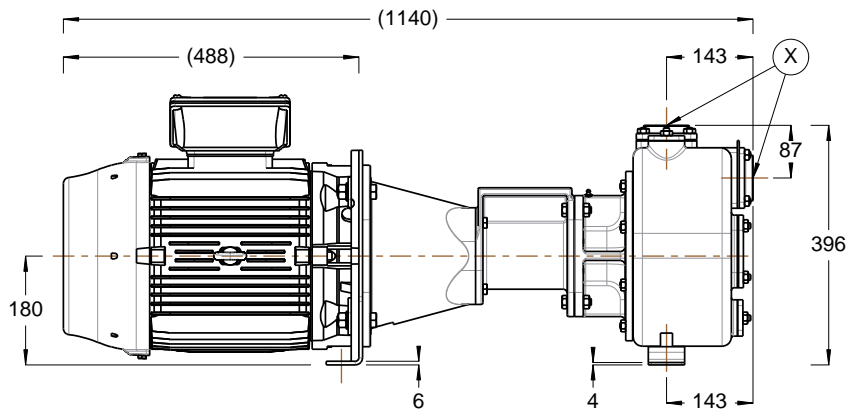
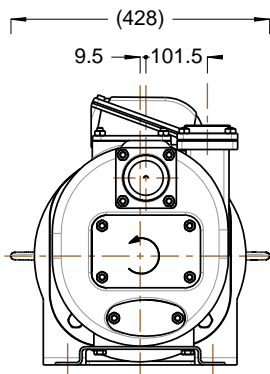

R2" BSP

