

S 69 K..BBT+F

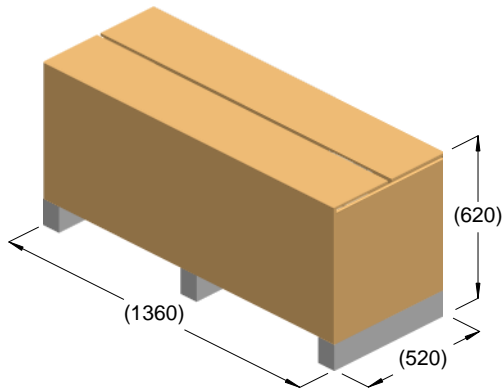

kg = 193
m³ = 0.44

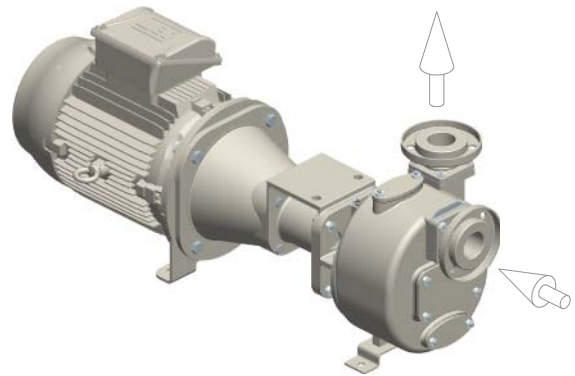

kg = 206

