

S 67 K..BBT+F

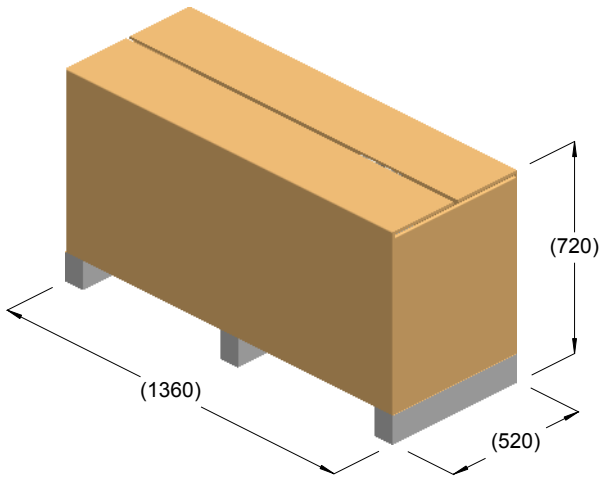

kg = 201
m³ = 0.51

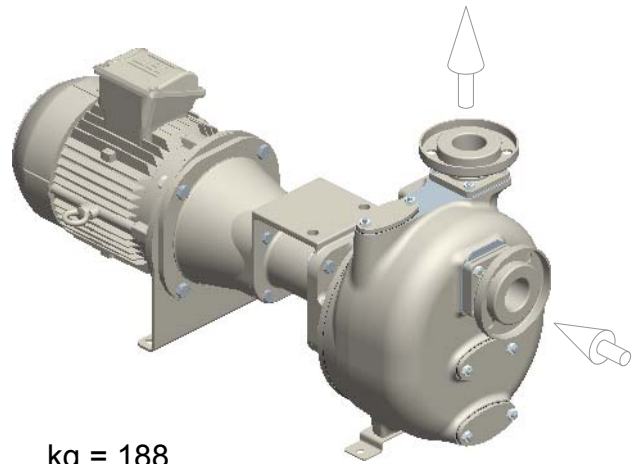

kg = 188

