

**S 66 K..BBT**

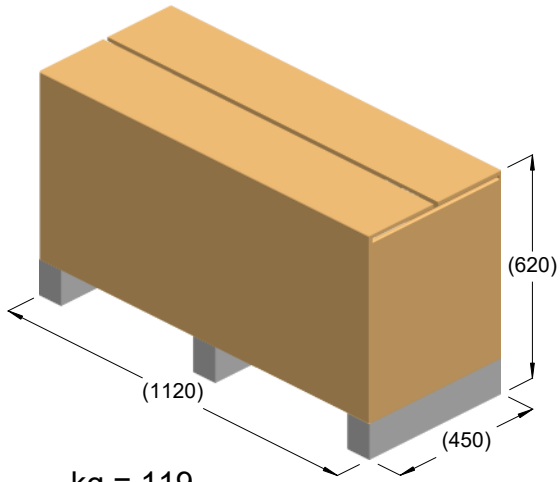

kg = 119  
m<sup>3</sup> = 0.31

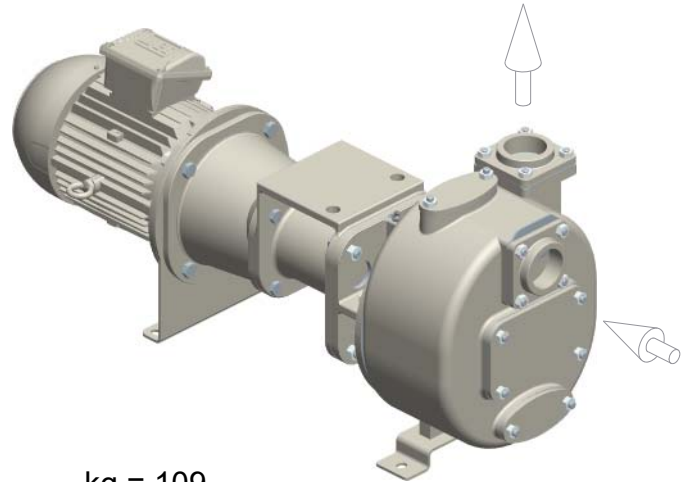

kg = 109

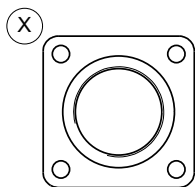
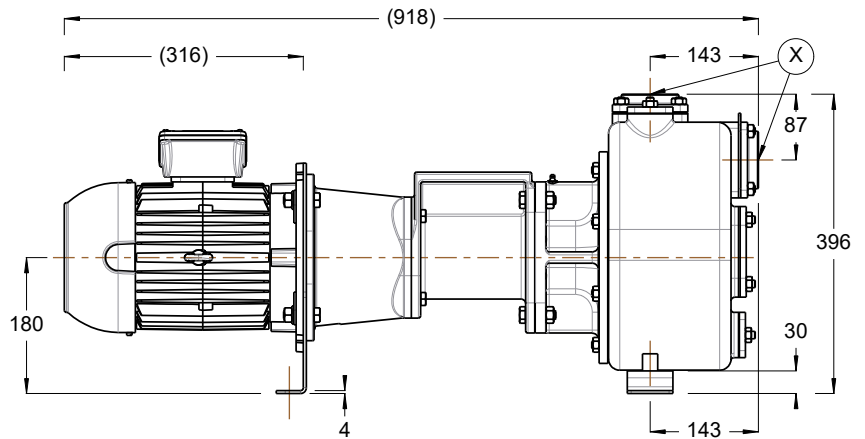
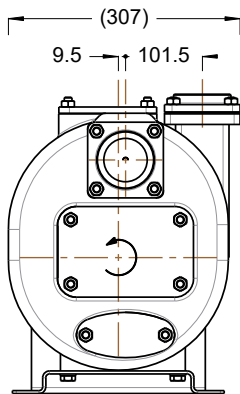

R2" BSP

