

S 66 K..BBT+F

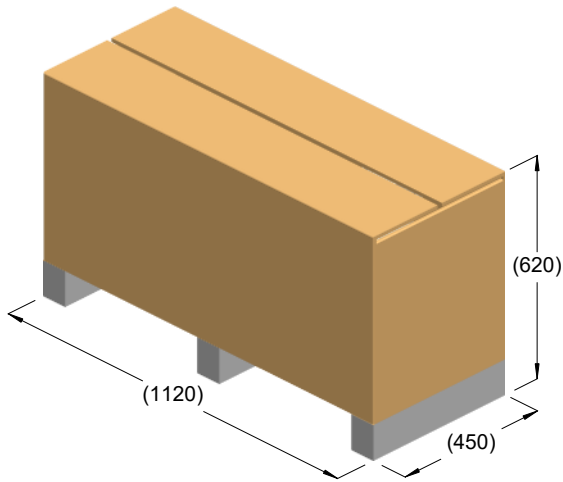

kg = 122
m³ = 0.31

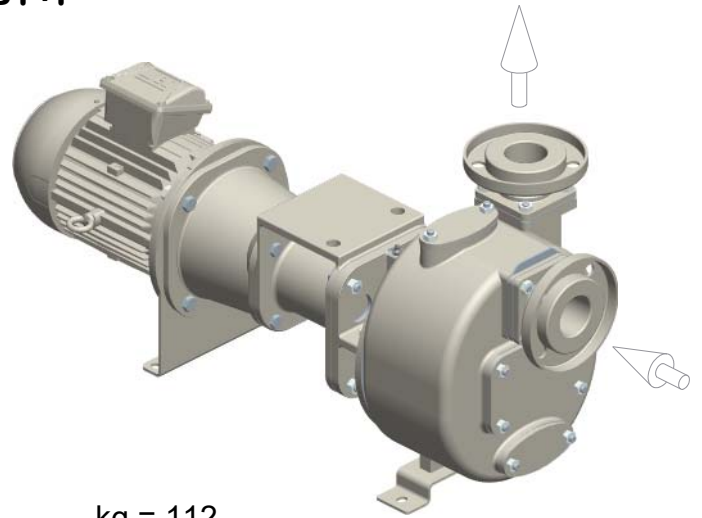

kg = 112

