

S 65 ...BBT

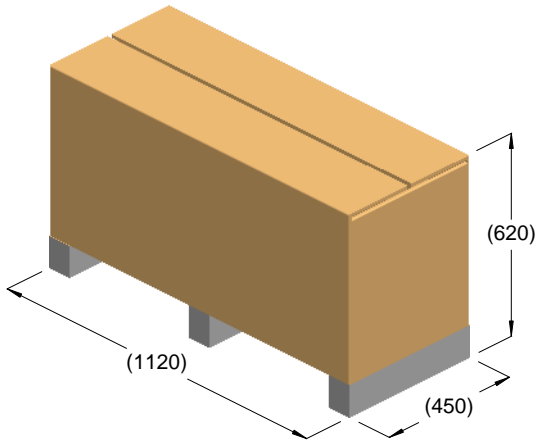

kg = 111
m³ = 0.31

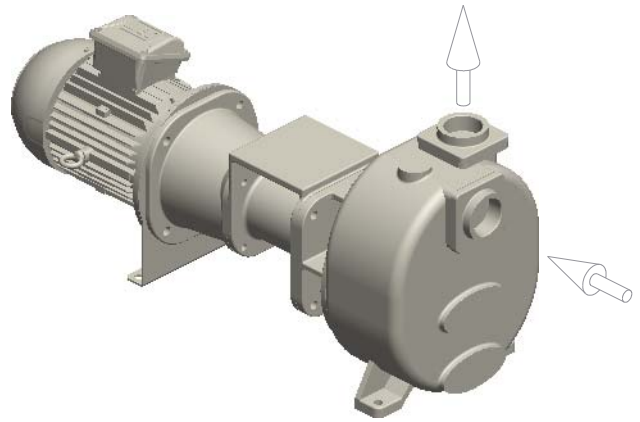

kg = 99

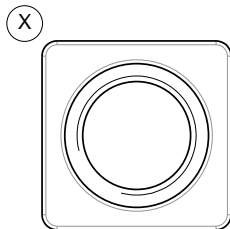
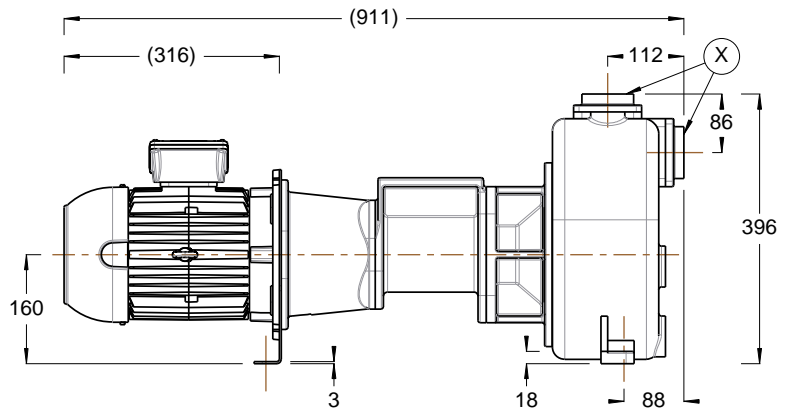
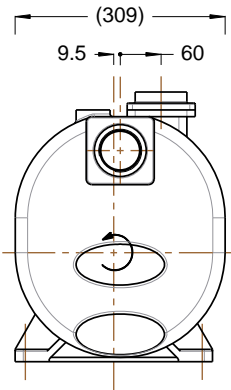

R2" BSP

