

S 65 ...BBT+F

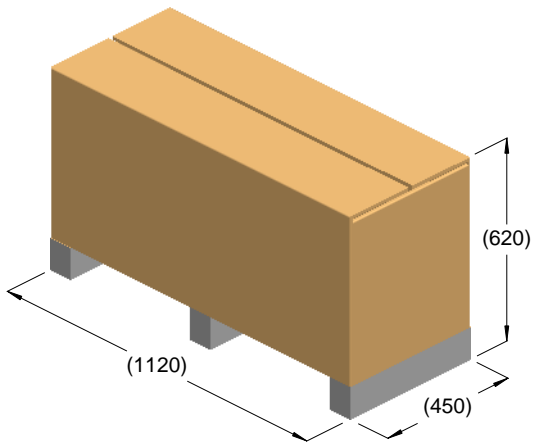

kg = 108
m³ = 0.31

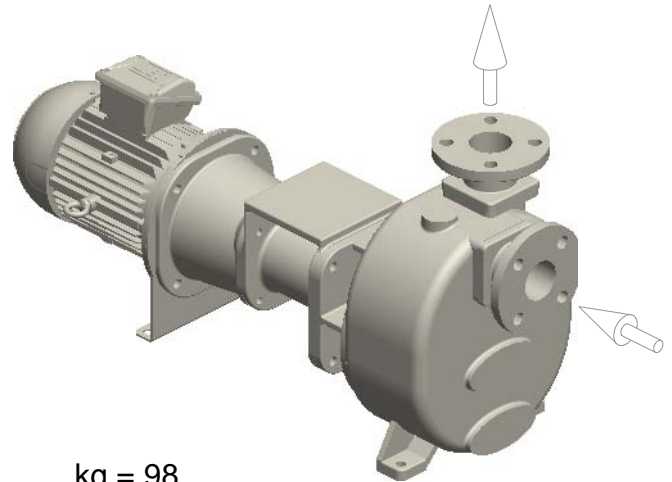

kg = 98

