

S 63 ...BBT

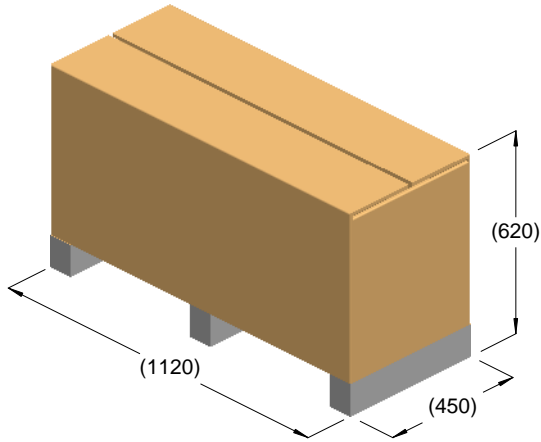

kg = 118
m³ = 0.31

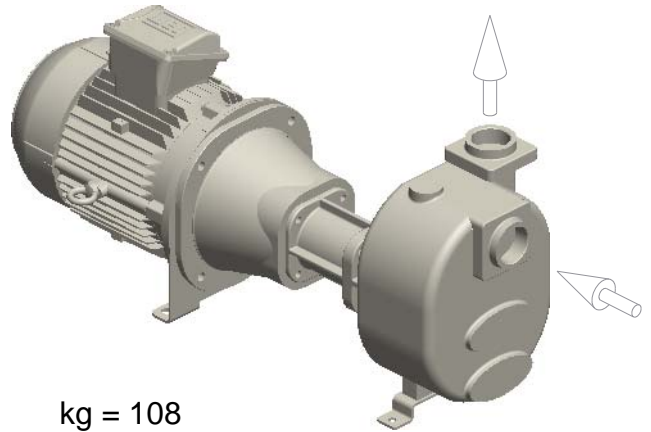

kg = 108

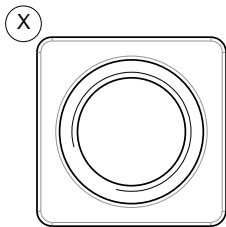
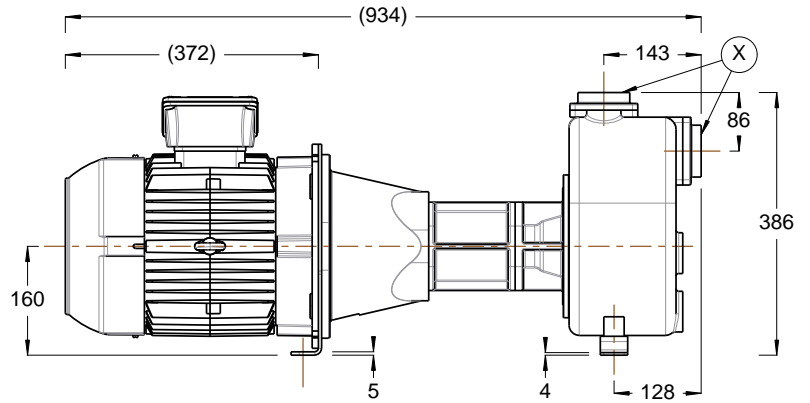
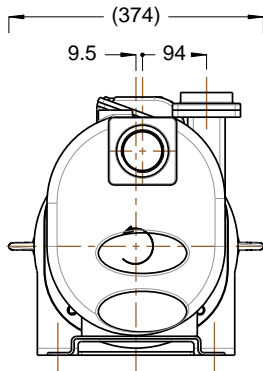

R2" BSP

