

S 61 K..BBT

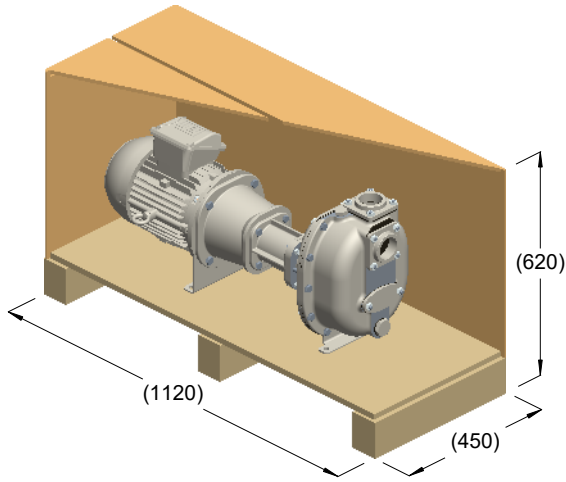

kg = 101
m³ = 0.31

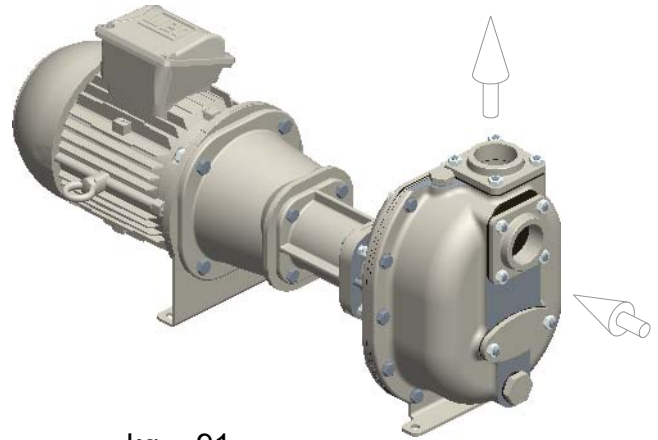

kg = 91

