

S 61 K..BBT+F

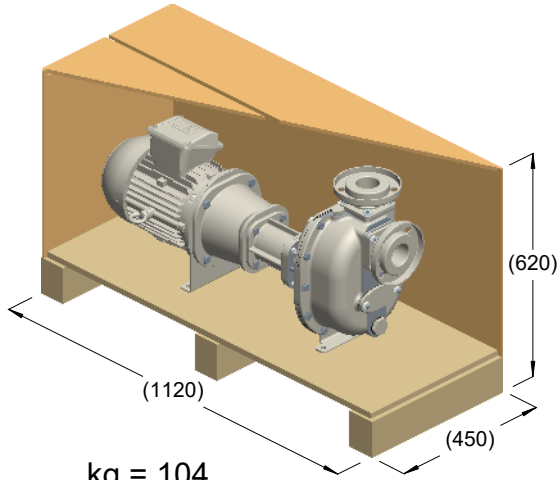

kg = 104
m³ = 0.31

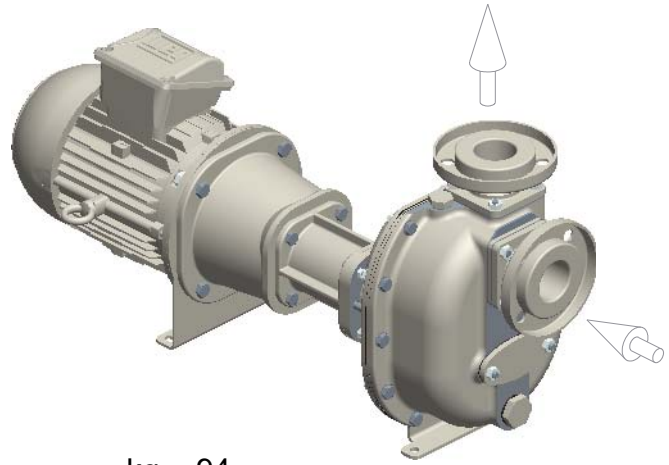

kg = 94

