

S 60 ...BBT52

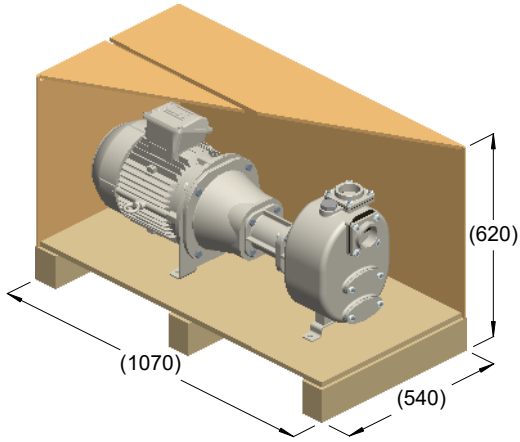

kg = 132
m³ = 0.36

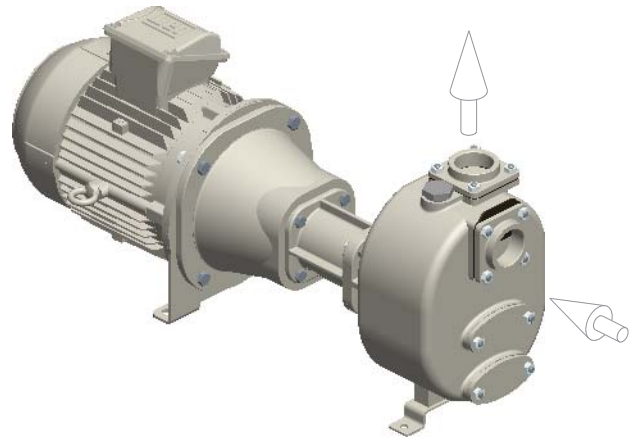

kg = 119

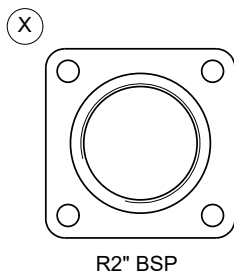
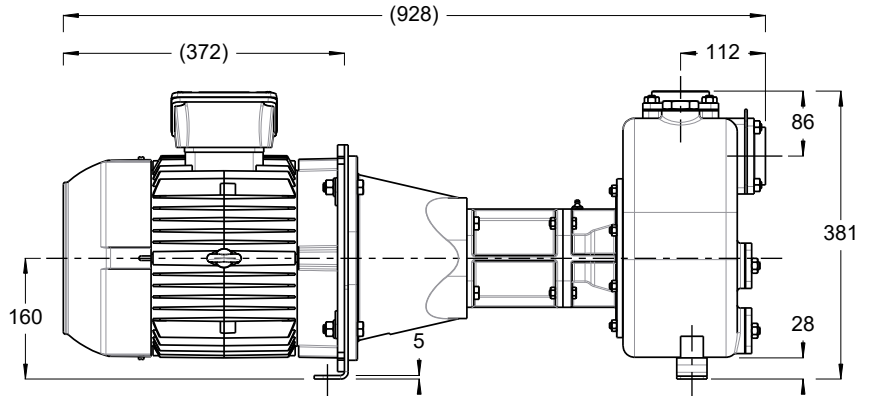
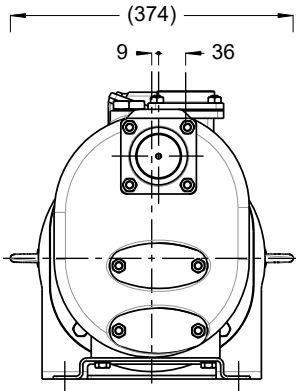

R2" BSP

