

S 60 ...BBT

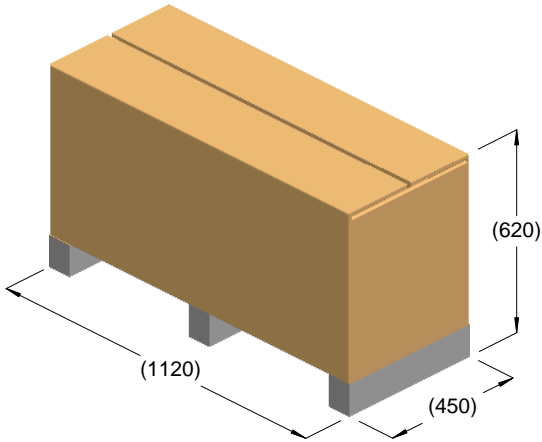

kg = 104
m³ = 0.31

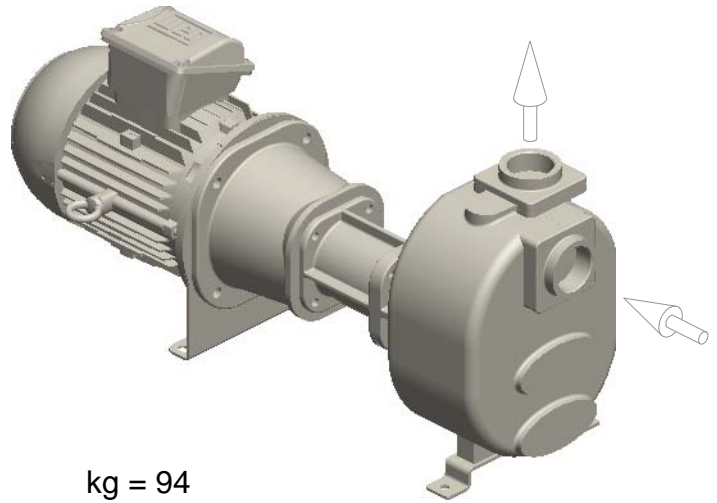

kg = 94

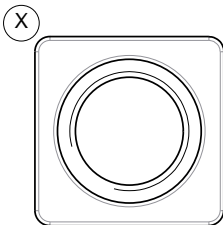
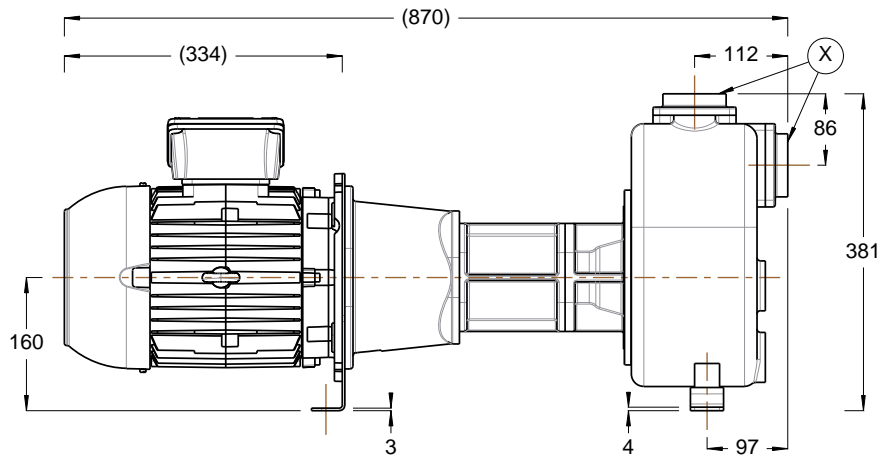
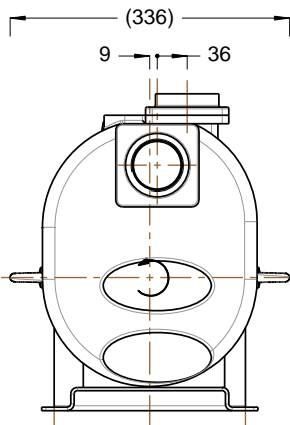

R2" BSP

