

S 60 ...BBT+F

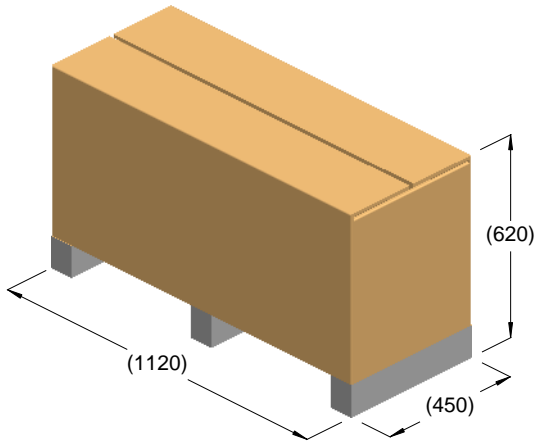

kg = 107
m³ = 0.31

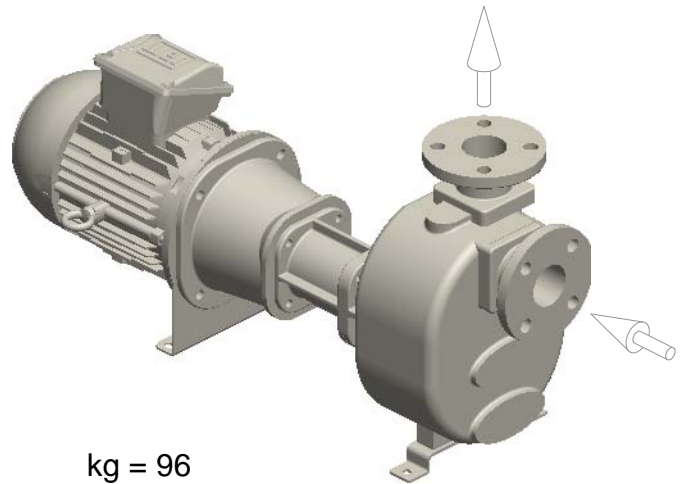

kg = 96

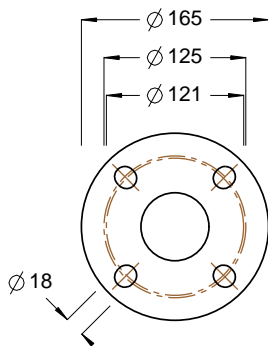
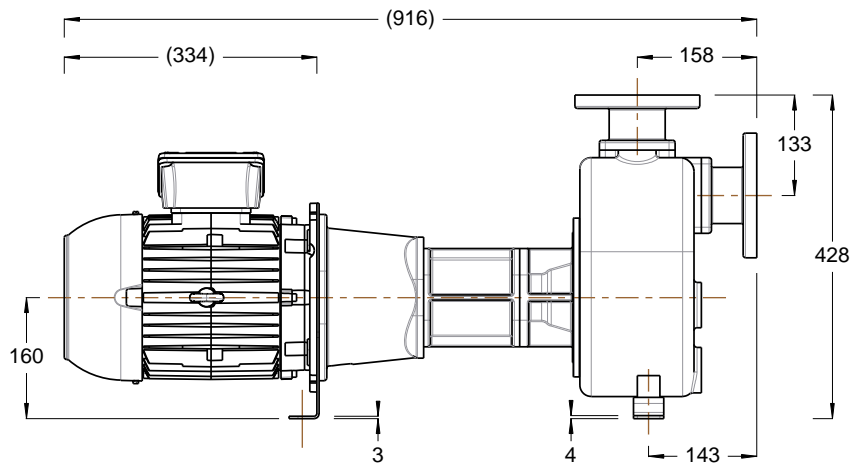
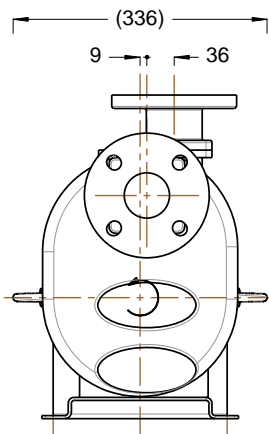

DN50 PN16 / ASA125 2"

