

S 51 K..BBT

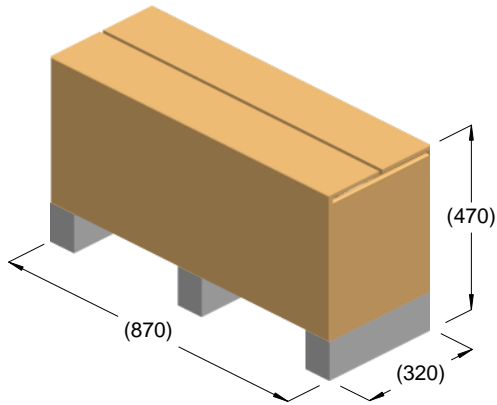

kg = 65
m³ = 0.16

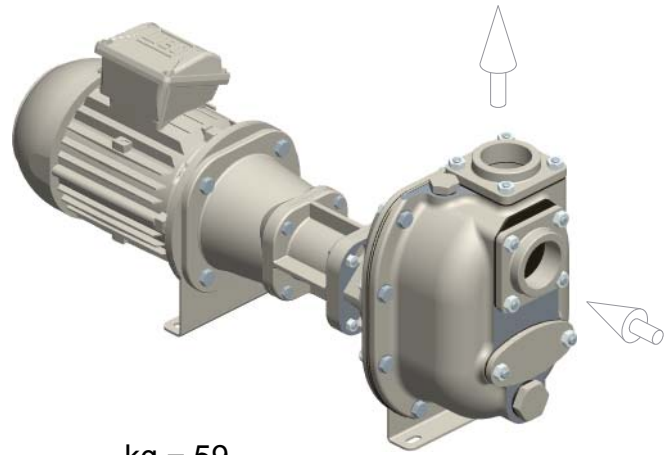

kg = 59

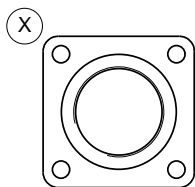
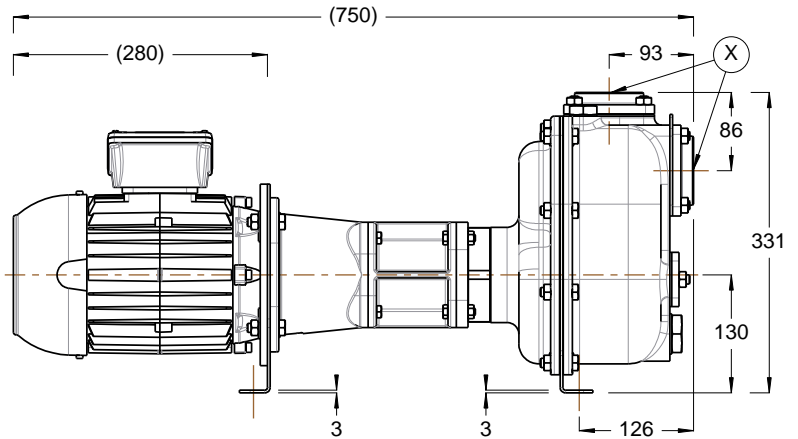
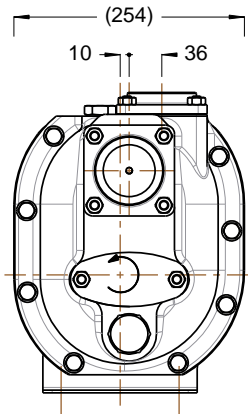

R2" BSP

