

S 50 ...BBT

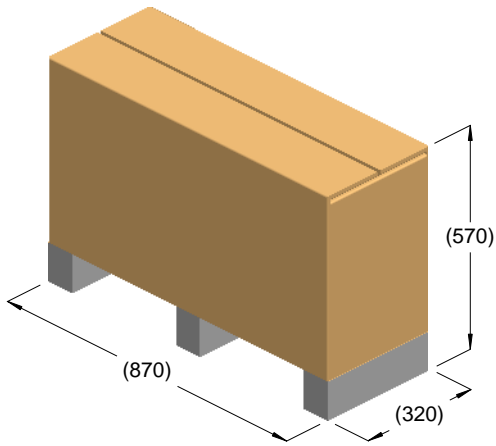

kg = 60
m³ = 0.16

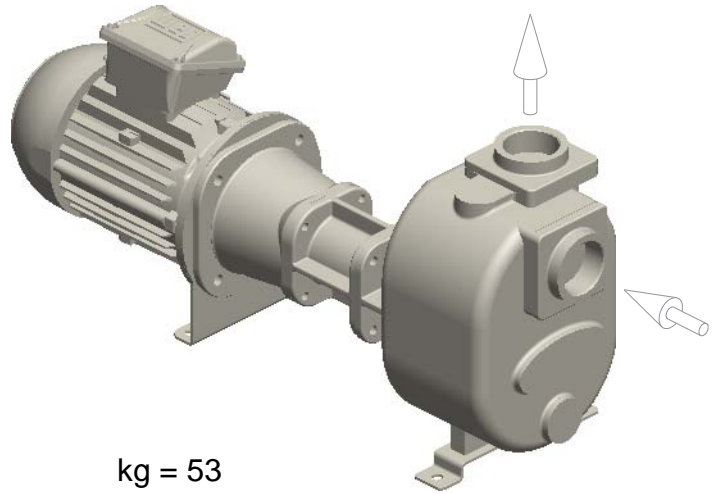

kg = 53

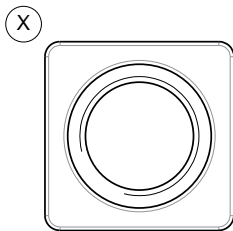
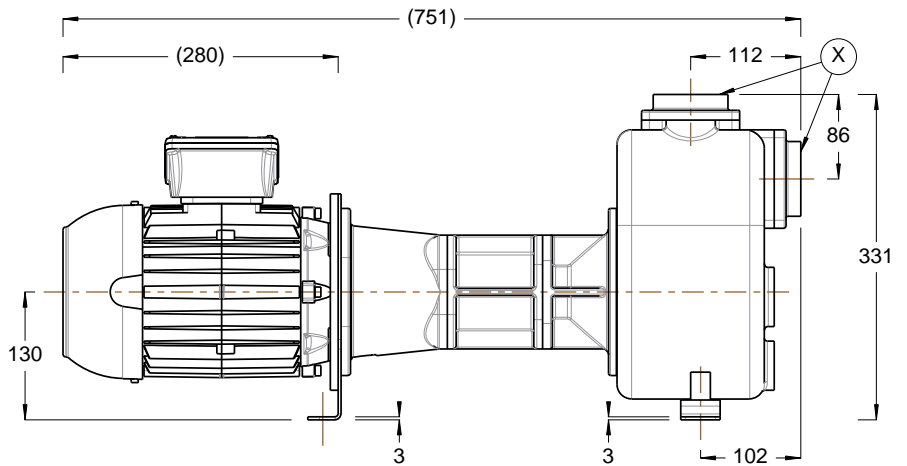
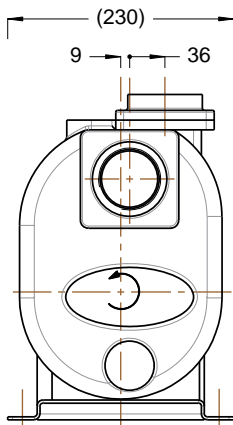

R2" BSP

