

S 50 ...BBT+F

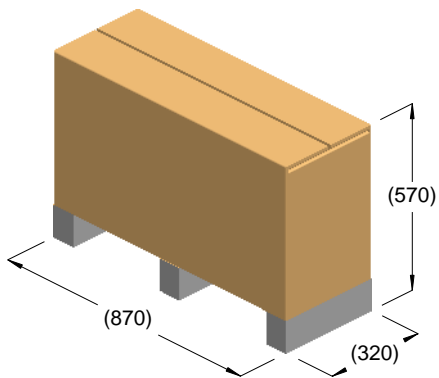

kg = 72
m³ = 0.16

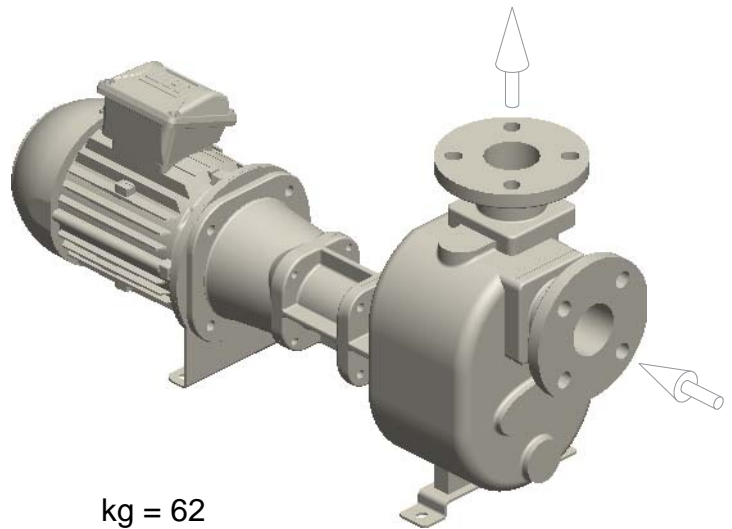

kg = 62

