

S 46 K..BBT

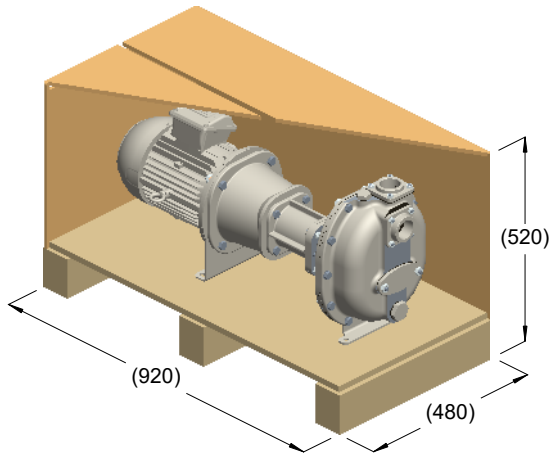

kg = 83
m³ = 0.27

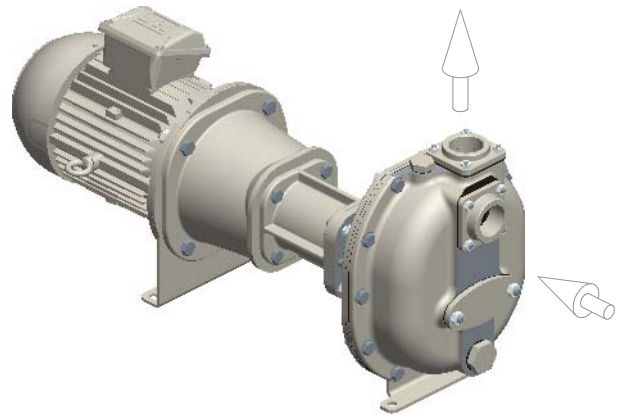

kg = 75

