

S 46 K..BBT+F

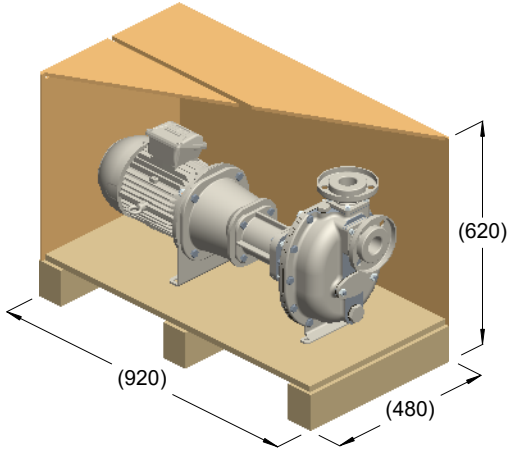

kg = 85
m³ = 0.27

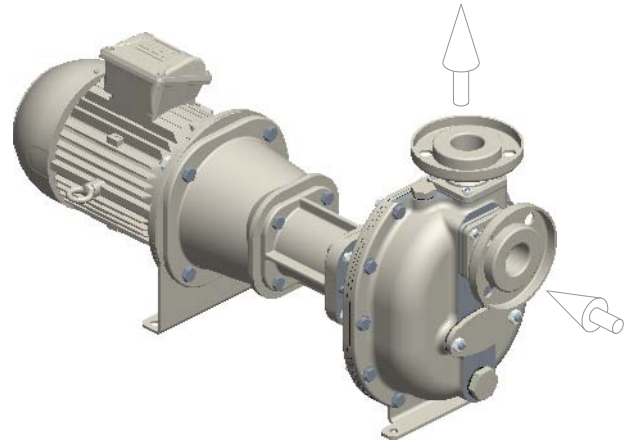

kg = 77

