

S 45 ...BBT

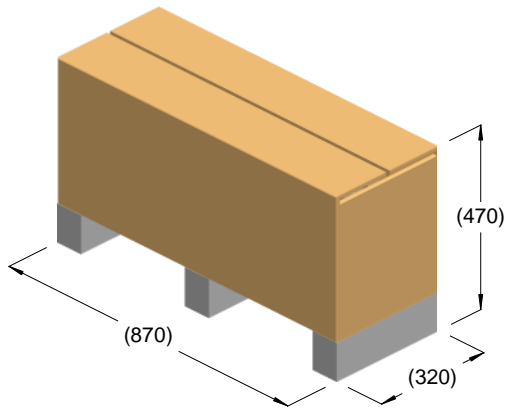

kg = 63
m³ = 0.16

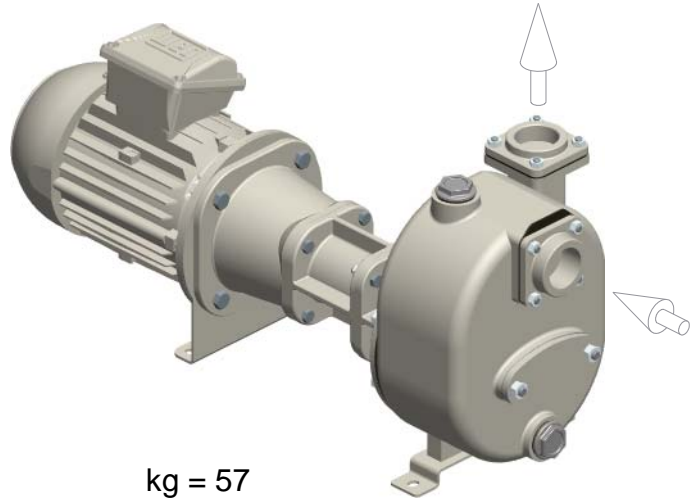

kg = 57

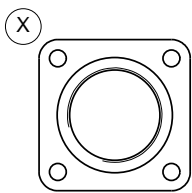
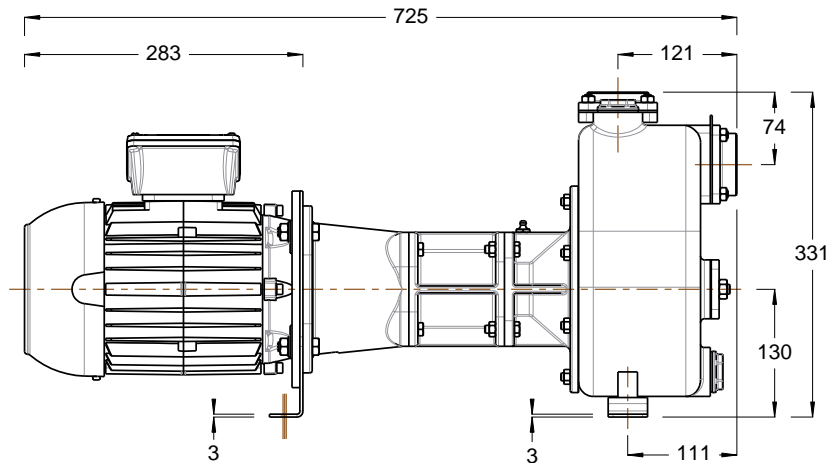
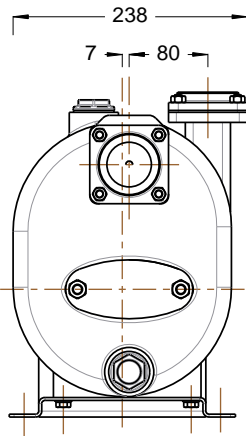

R 1½" BSP

