

**S 45 ...BBT+F**

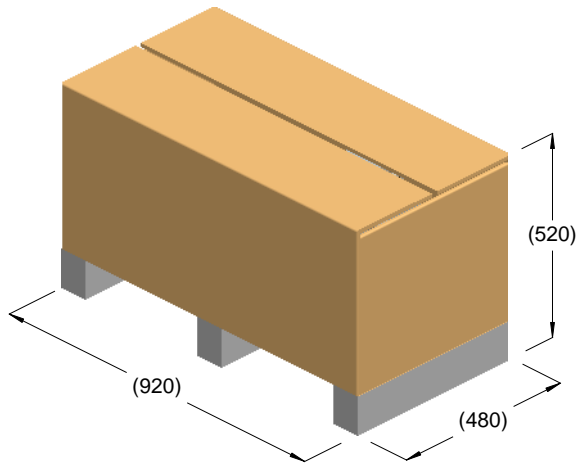

kg = 69  
m<sup>3</sup> = 0.27

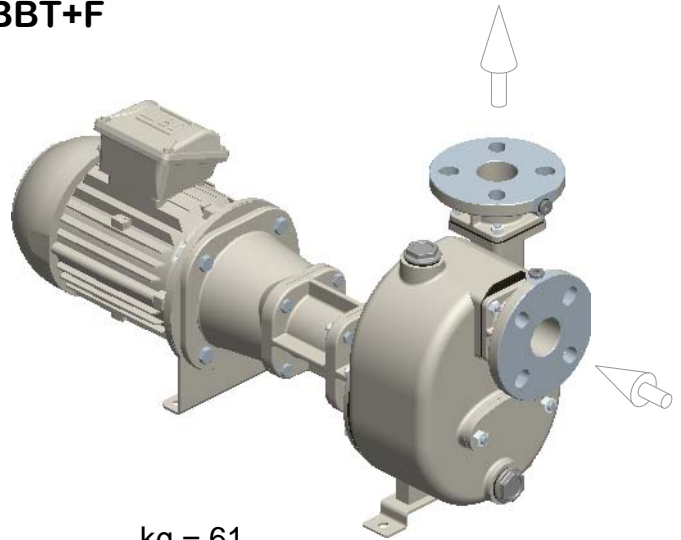

kg = 61

