

S 41 ...BBT+F

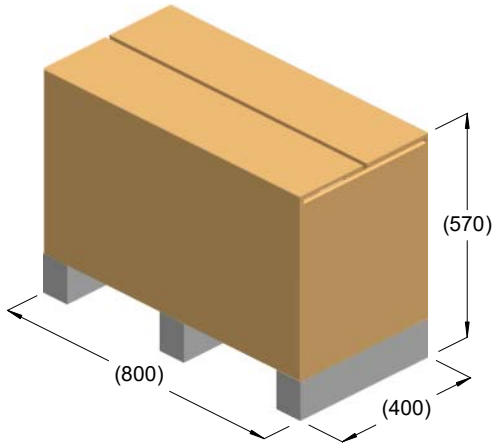

kg = 51
m³ = 0.18

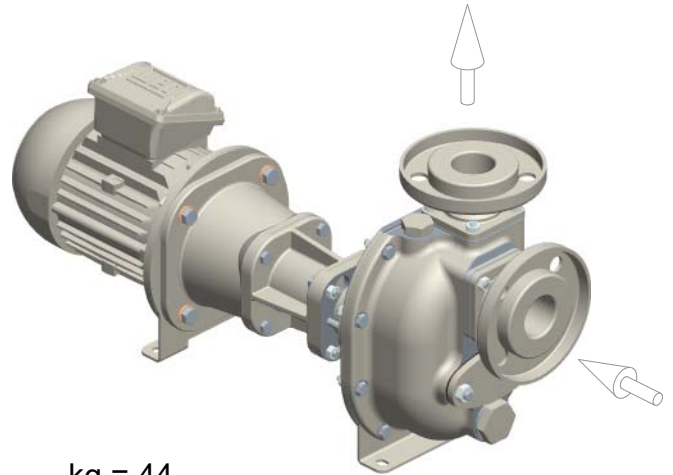

kg = 44

