

S 40 ...BBT

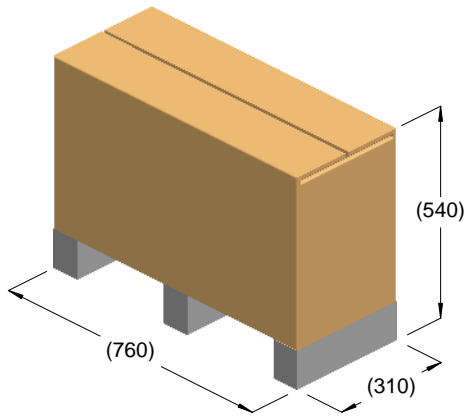

kg = 43
m³ = 0.13

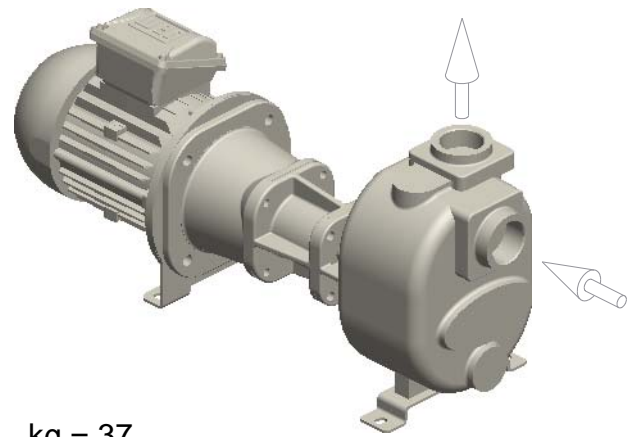

kg = 37

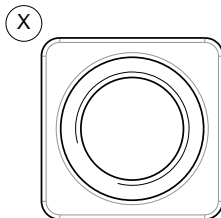
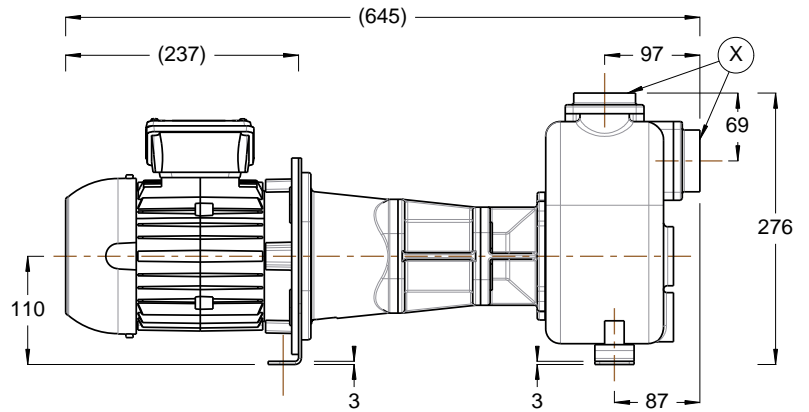
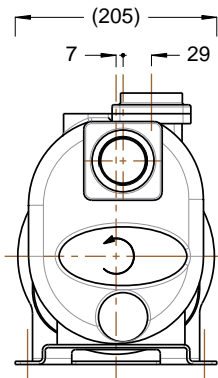

R1½" BSP

