

S121 ...BBT

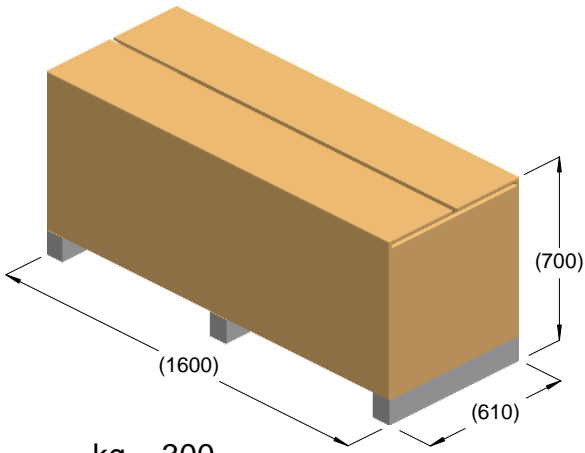

kg = 300
m³ = 0.68

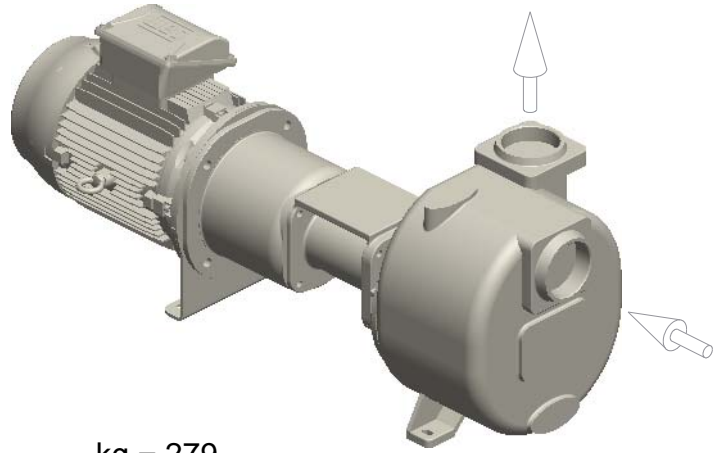

kg = 279

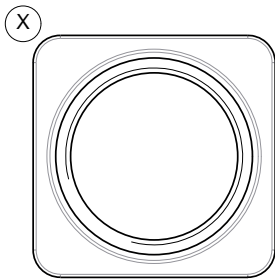
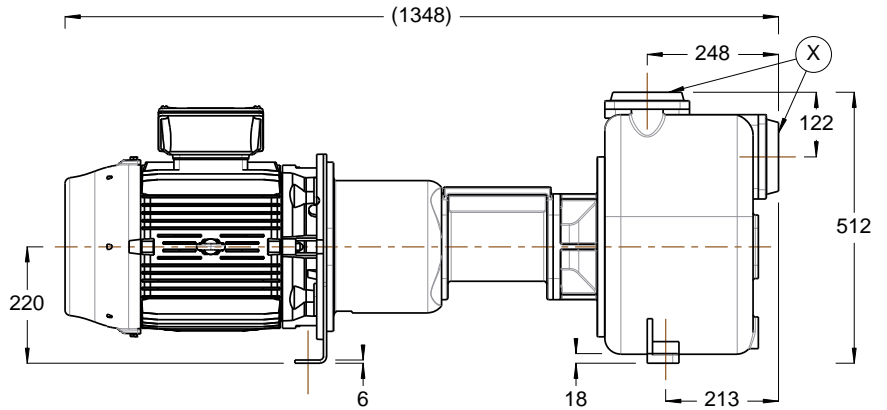
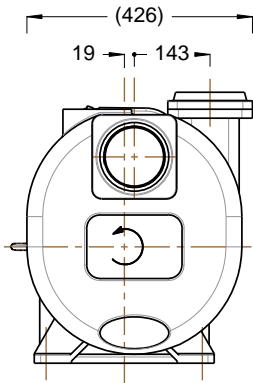

R4" BSP

