

S121 ...BBT+F

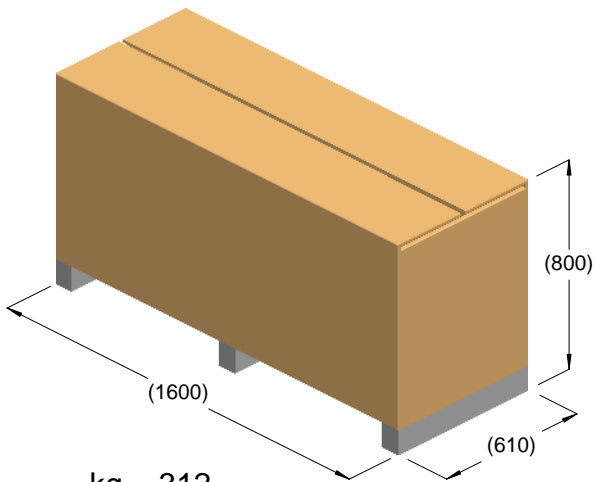

kg = 312
m³ = 0.78

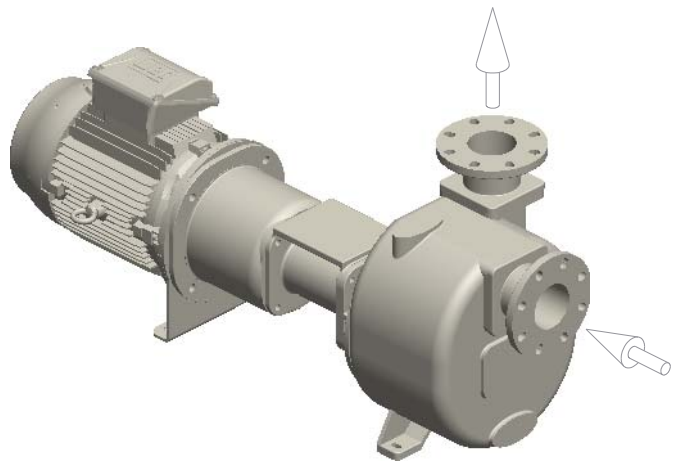

kg = 290

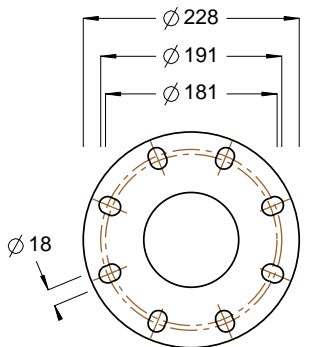
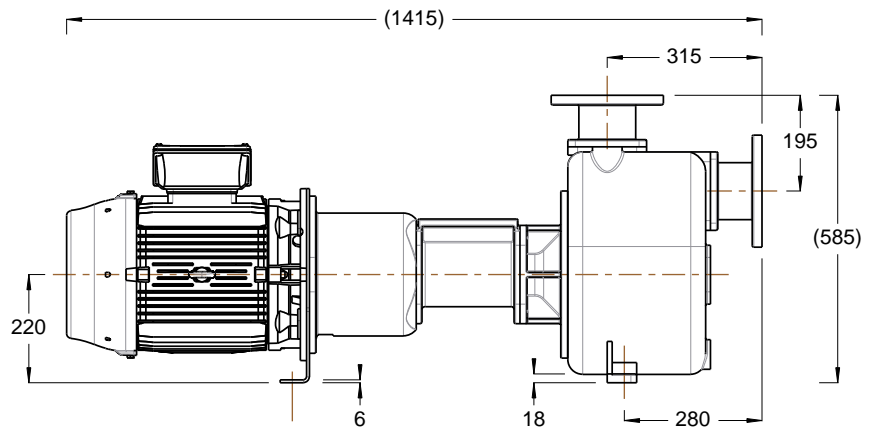
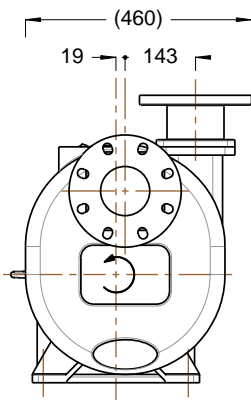

DN100 PN16 / ASA125 4"

