

S108 ...BBT

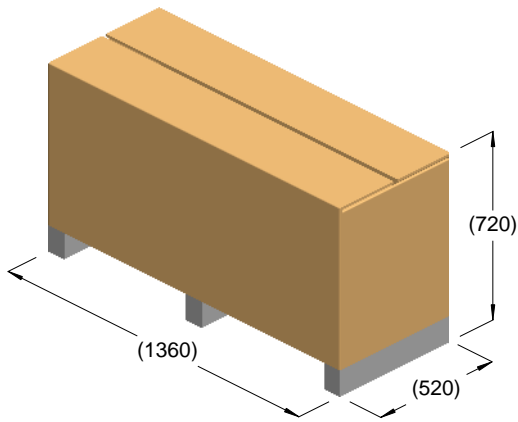

kg = 276
m³ = 0.51

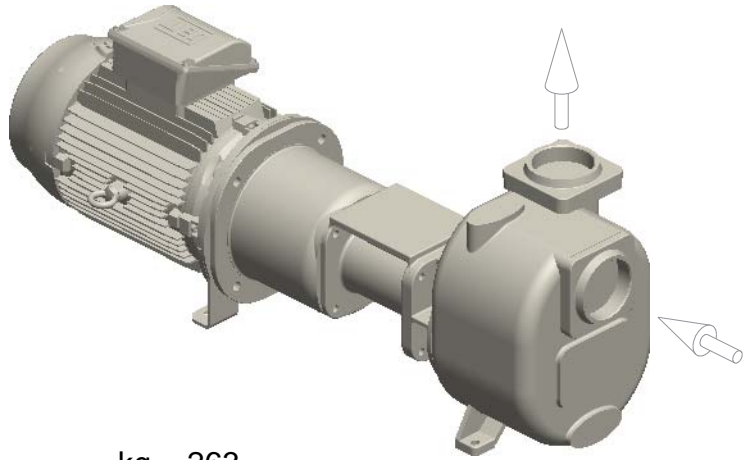

kg = 263

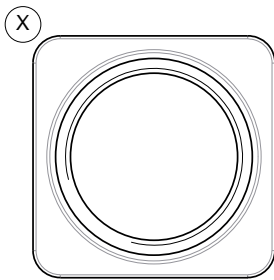
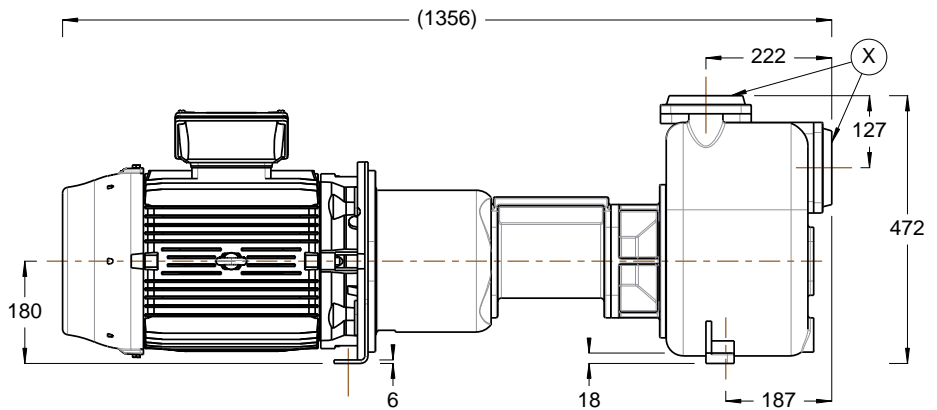
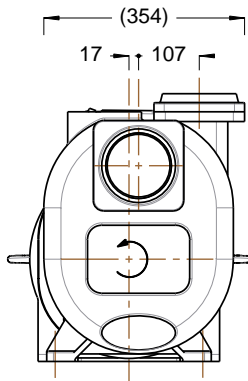

R4" BSP

