

**S105 K..BBT**

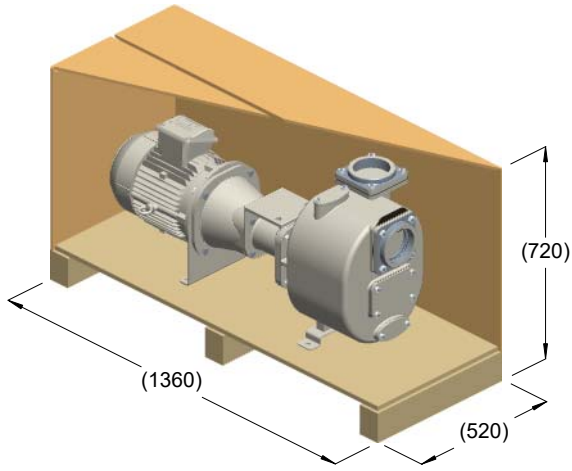

kg = 209  
m<sup>3</sup> = 0.51

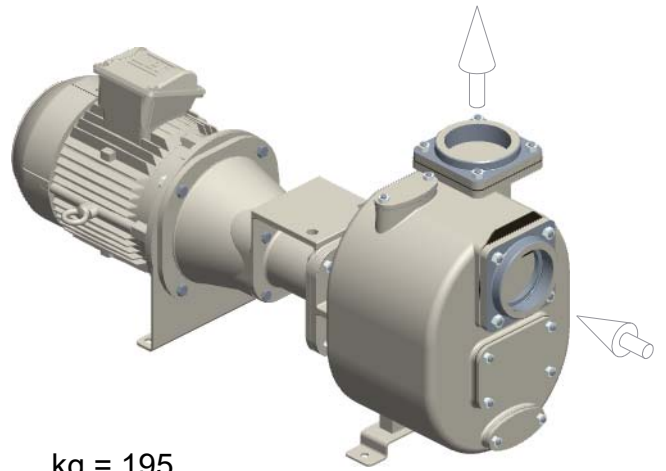

kg = 195

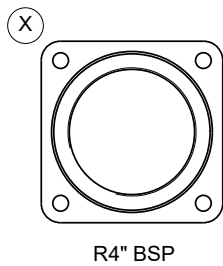
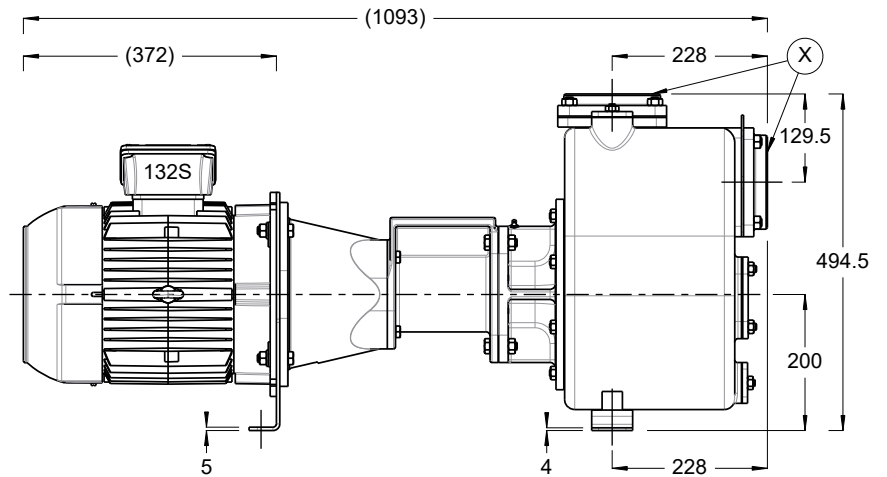
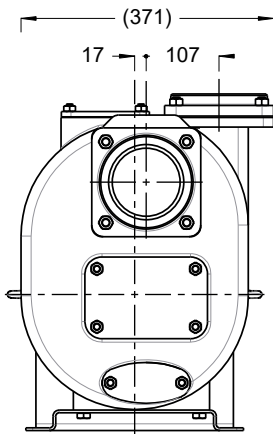

R4" BSP

