

S105 ...BBT+F

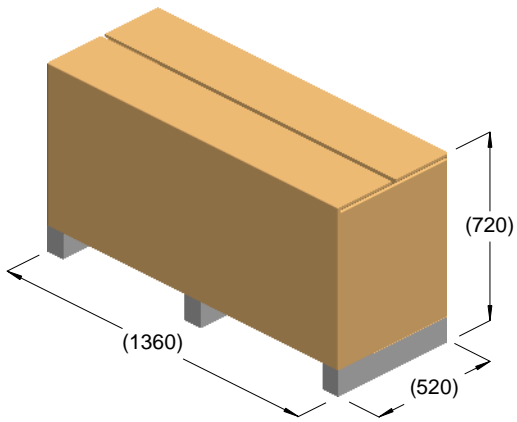

kg = 186
m³ = 0.51

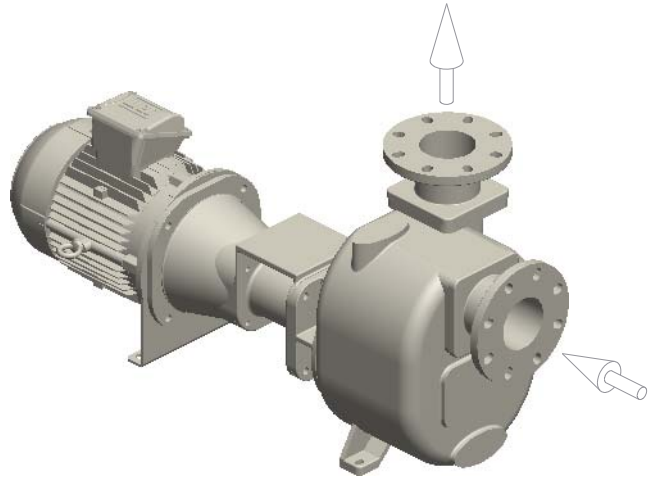

kg = 171

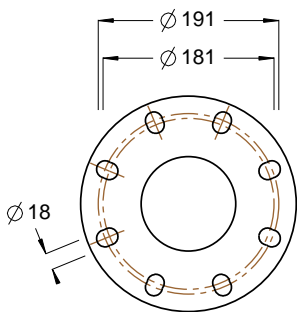
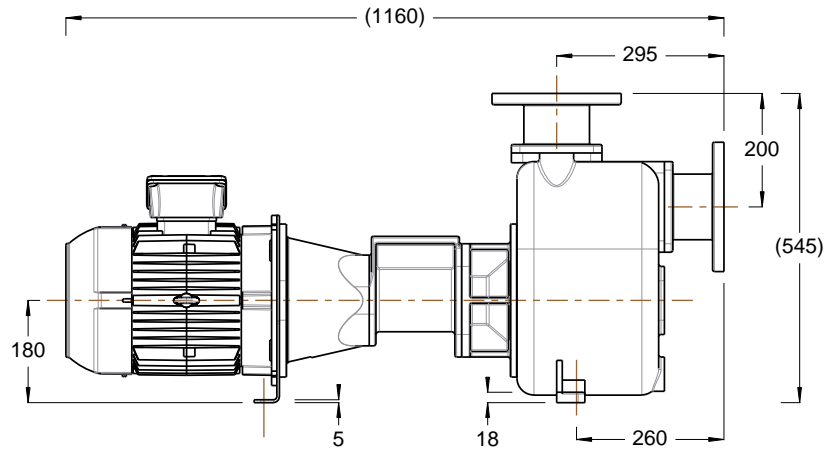
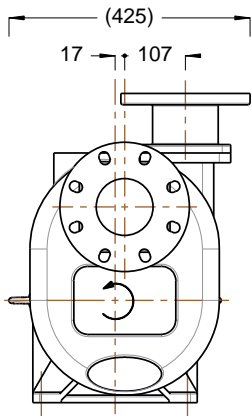

DN100 PN16 / ASA125 4"

