

S100 ...BBT

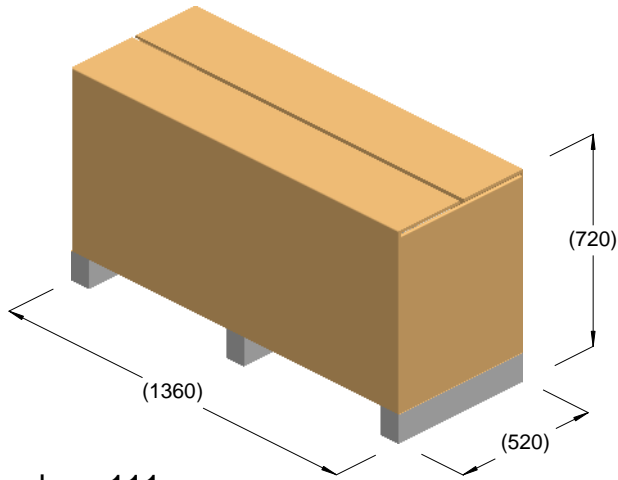

kg = 111
m³ = 0.51

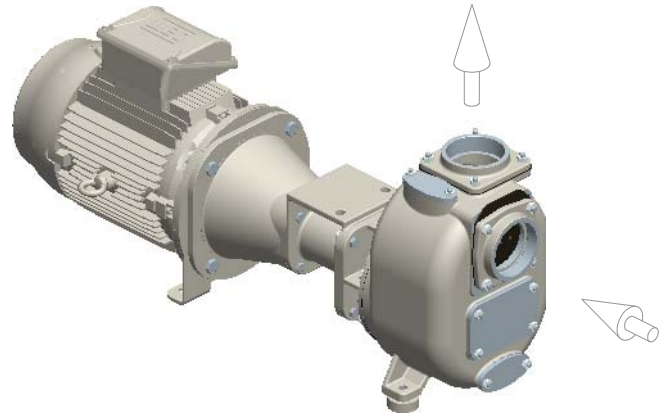

kg = 98

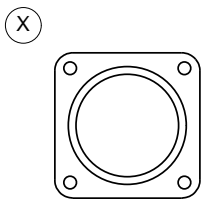
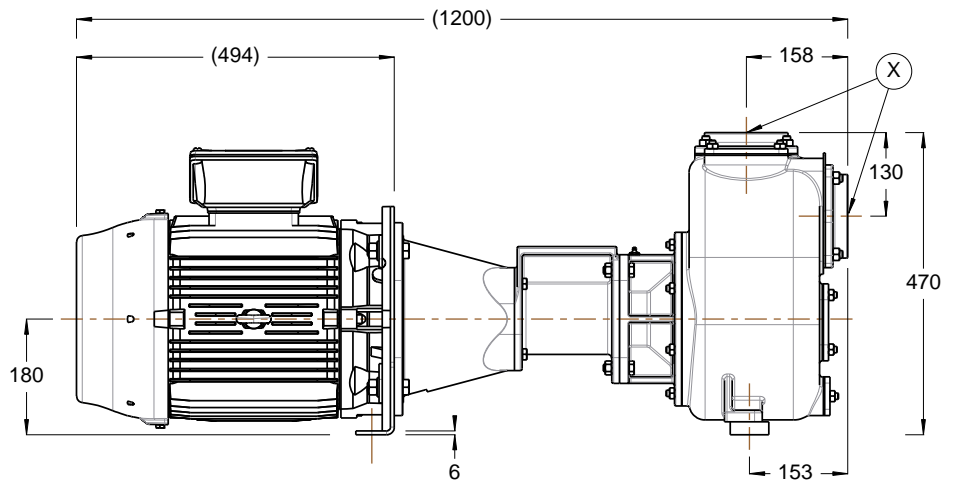
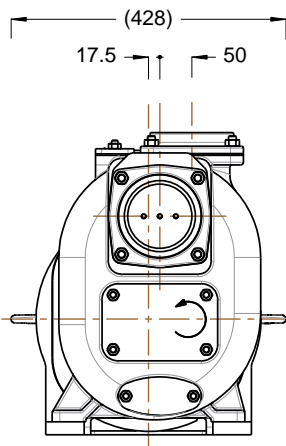

R4" BSP

