

S 91 ...B+F

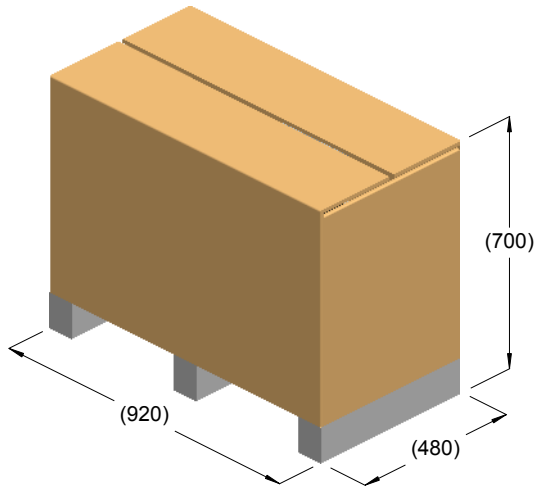

kg = 125
m³ = 0.310

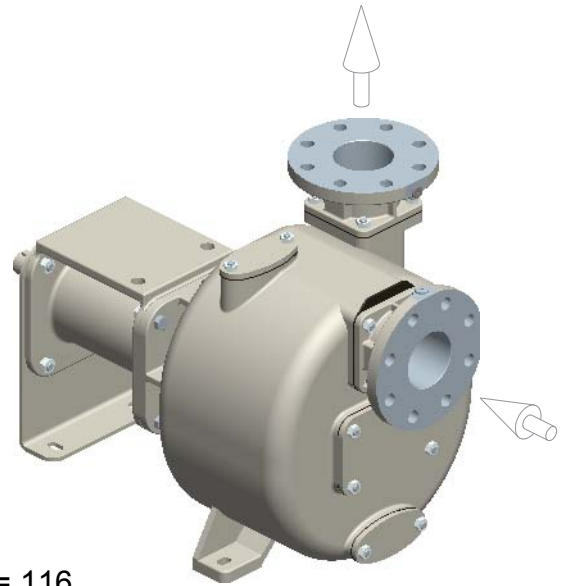

kg = 116

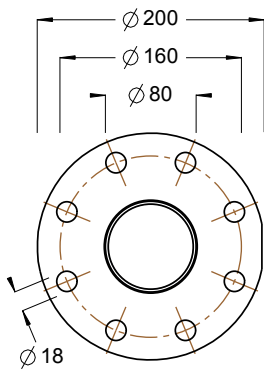
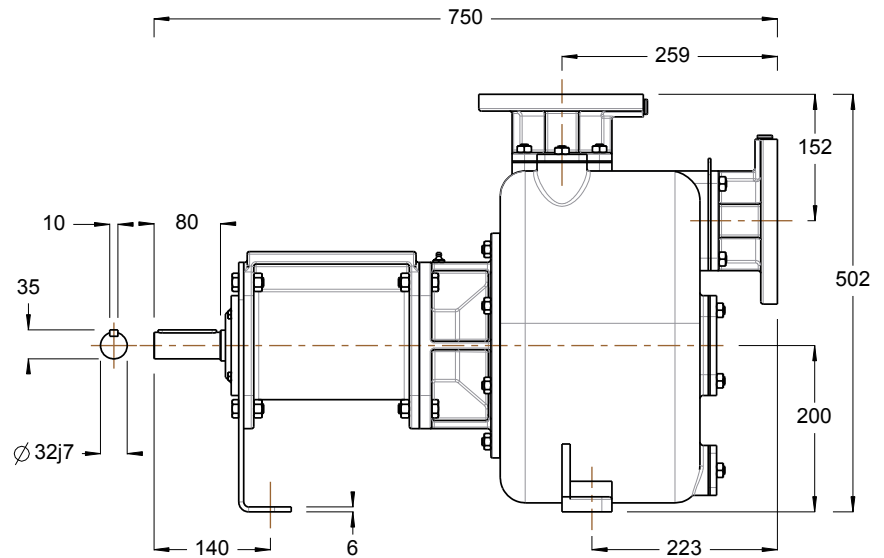
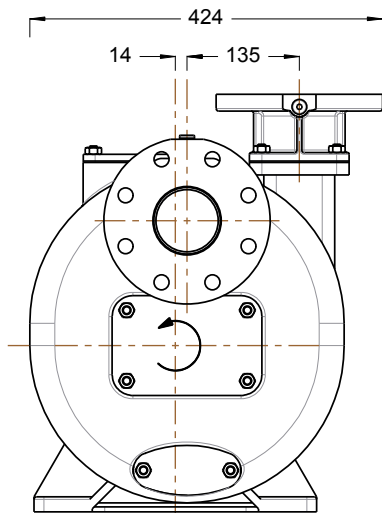

ISO DN80 PN16

